

		<p>Project title: Development of sensor-based Citizens' Observatory Community for improving quality of life in cities</p> <p>Acronym: CITI-SENSE Grant Agreement No: 308524</p> <p>EU FP7- ENV-2012 Collaborative project</p>
---	---	---

Deliverable D 8.4

Sensor Platforms Enhancement

Work Package 8

Date: 24.11.2015

Version: 9.0

Leading Beneficiary:	UCAM
Editor(s):	Olalekan Popoola (UCAM), Franck R. Dauge (NILU)
Author(s) (alphabetically):	Franck R. Dauge (NILU), Núria Castell (NILU), Olalekan Popoola (UCAM), Roderic Jones (UCAM), Karen Galea (Edinburgh), Vlasta Svecova (Ostrava)
Dissemination level:	RE (Restricted)

Versioning and contribution history

Version	Date issued	Description	Contributors
1.0	21.08.2015	Assessment of platform performance: Laboratory and field assessment of sensor platforms	Olalekan Popoola, Franck Dauge
2.0	21.09.2015	Assessment of platform performance: Laboratory and field assessment of sensor platforms	Olalekan Popoola, Franck Dauge
3.0	12.10.2015	Latest results and enhancement of platforms-Oslo	Núria Castell
4.0	30.10.2015	Corrected version, based on reviewers inputs	Franck Dauge
5.0	09.11.2015	Corrected version taking into account reviewers suggestions and comments.	Olalekan Popoola
6.0	13.11.2015	Latest results and enhancement of platforms-Edinburgh, Ostrava/Prague, Ljubljana and Barcelona	Karen Galea, Vlasta Svecova, Tom Cole-Hunter, David Kocman
7.0	17.11.2015	Latest results and enhancement of platforms-Vienna	Alexander Arpaci
8.0	23.11.2015	Latest results and enhancement of platforms-Belgrade	Milena Jovasevic-Stojanovic
9.0	24.11.2015	Coordinator review	Sonja Grossberndt and Alena Bartonova

Peer review summary

Internal review 1			
Reviewer	Leif Marsteen (NILU)		
Received for review	14.10.2015	Date of review	16.10.2015

Internal review 2			
Reviewer	Sverre B Holøs (SINTEF)		
Received for review	23.10.2015	Date of review	26.10.2015

Executive Summary

The CITI-SENSE project aims primarily to develop citizens' air quality observatories. This was made possible by employing swiftly developing technologies which gave rise to user-friendly, extremely low-maintenance and compact devices. Several potential instrument providers were identified at an early stage of the project. Eight of them joined the consortium and were committed to provide the project with all necessary instrumentation, including both mobile and stationary multi-gas platforms. PM measurement capability was added to some of the devices along the project development.

WP8 has evaluated all involved devices. UCAM lead the task and endorsed responsibility for field tests of air quality monitors while NILU performed laboratory control of the involved air quality platforms. The radon sensor platform has been tested by the provider (OBEO) independently.

The field experiments concerned a maximum number of two AQ units. Several large-scale field tests involving up to 24 similar units took place in different cities at a later stage. Results from one of these co-location experiments, the one done in Oslo, is hereunder presented, together with measurements obtained by UCAM and NILU.

Although laboratory controls were not sufficiently stringent to provide a full metrological characterization of the tested instruments, results obtained for Geotech, Ateknea and Atmospheric sensors left a good impression by showing excellent performance. Field measurements showed a very different picture, with measurement quality highly varying, both between units and between measured components. Correction measures have been implemented with acceptable results.

A full analysis of the field trials of the AQ devices (provided by Geotech, Atmospheric Sensors and Ateknea) will be part of the Deliverable D8.5.

Table of contents

EXECUTIVE SUMMARY	3
TABLE OF CONTENTS	4
1 PLATFORMS ASSESSMENT	5
1.1 PLATFORM DESCRIPTION	5
1.1.1 Geotech AQMesh	5
1.1.2 Atmospheric sensors.....	5
1.1.3 Ateknea LEO	6
1.1.4 Airbase CanarIT	6
1.1.5 CVUT	7
1.1.6 Dunavnet	7
1.2 FIELD ASSESSMENT OF SENSOR PLATFORMS	7
1.2.1 Cambridge Field Instrumentation.....	8
1.2.2 Field assessment: Geotech / AQMesh pod	12
1.2.3 Field assessment: Ateknea units.....	13
1.2.4 Field assessment: Atmospheric Sensor nodes	14
1.2.5 Field assessment: CVUT node	16
1.2.6 Overview of field performance of the platforms	18
1.3 LABORATORY ASSESSMENT OF SENSOR PLATFORMS.....	19
1.3.1 Laboratory set-up	20
1.3.2 Test protocol.....	22
1.3.3 Results	23
1.3.4 Geotech AQMesh	23
1.3.5 Ateknea LEO.....	26
1.3.6 Atmospheric Sensor node.....	29
1.3.7 Airbase CanarIT	32
1.3.8 Dunavnet node.....	33
1.3.9 Discussion	35
2 FIELD TRIALS OF PLATFORMS	38
2.1 OSLO STUDY	38
2.1.1 Description of study area.....	38
2.1.2 Methodology	42
2.1.3 Field Results: Geotech/AQMesh platform	43
2.1.4 Conclusions	54
ANNEX	55
A. CAMBRIDGE FIELD ASSESSMENT	55
B. LABORATORY TESTS: DATA SERIES	59
C. SUMMARY OF EDINBURGH WP2 SENSOR FIELD TESTS	69
D. SUMMARY OF OSTRAVA AND PRAGUE FIELD TRIAL.....	73
E. SUMMARY OF BARCELONA FIELD TRIAL	77
F. SUMMARY OF LJUBLJANA SENSOR FIELD TESTS	78
G. SUMMARY OF VIENNA SENSOR FIELD TESTS	81
H. SUMMARY OF BELGRADE SENSOR FIELD TESTS	82

1 PLATFORMS ASSESSMENT

This section focuses on results from both the laboratory and field assessment studies of the platforms that will be used in the studies for the CITI-SENSE project. Laboratory performances were evaluated at NILU while UCAM conducted field assessments of the platforms. Three sensor platforms (Geotech/AQMesh, Atmospheric Sensors (AS) and Ateknea nodes) were evaluated both for their field and laboratory performance. Additional units studied although not approved for use in the final deployment phase, were the CVUT node (field assessment at UCAM), DNET and Airbase (laboratory tested at NILU). A JSI unit was also provided for laboratory test but never tested. Details regarding WP8's approval of platforms can be found in former report [Performance analysis of sensor platforms for outdoor use].

1.1 Platform description

1.1.1 Geotech AQMesh

AQMesh units are battery driven stationary platforms which measure four gaseous components (carbon monoxide, nitric oxide, ozone and nitric dioxide in the CITI-SENSE configuration) as well as temperature, relative humidity and atmospheric pressure. An integrated optical particulate counter developed by Geotech and a noise sensor are also available on the latest units. Table 1 gathers platform information relevant for our tests on the gas sensors. Standard AQMesh units deliver one-hour averaged data. An integrated GPRS modem allows data transfer to Geotech's server. Data are available on a user-friendly dedicated web-site.

AQMesh units have gone through several major modifications since the beginning of the project. The M12 pilot units were referred to as V3.0 by Geotech. Results of the tests are not presented in the following. All test results displayed in this reports were obtained with version V3.5 of the pods. AQMesh description of the two versions follows:

- V3.0 - The original Alphasense NO₂ sensor did not separate NO₂ and O₃ well (unfiltered for O₃ and susceptible to multiple cross-gas effects). The O₃ sensor had similar problems.
- V3.5 - Driven by the O₃-filtered NO₂ sensor from Alphasense, as supplied around the end of 2014. This sensor gave better performance, particularly in separation of NO₂ and O₃ and Geotech changed its processing algorithm accordingly.

Table1: Geotech AQMesh gas sensing specifications

Gas	CO	NO	NO ₂	O ₃
Sensor technology	Electrochemical	Electrochemical	Electrochemical	Electrochemical
Measuring range	0-5000 ppb	0-2000 ppb	0-200 ppb	0-200 ppb
Sensor provider	Alphasense	Alphasense	Alphasense	Alphasense
Sensor type	CO-B4	NO-B4	NO2-B42F	OX-B421

1.1.2 Atmospheric sensors

Atmospheric sensors joined the consortium in 2014. The units are designed as stationary platforms for indoor measurements. They are not weather-proof and work on mains supply. They measure six gaseous components (carbon monoxide, nitric oxide, ozone, nitric dioxide, tot VOC and CO₂) as well as temperature, relative humidity and atmospheric pressure. An integrated optical particulate

counter (Alphasense) and a noise sensor are also available on these units. Table 2 gathers information on its embedded gas sensing devices. An integrated GPRS modem regularly sends data to Atmospheric sensors server. Collected data were available as Excel files on a FTP site.

Table2: Atmospheric Sensors node gas sensing specifications

Gas	CO	NO	NO ₂	O ₃	Tot VOC	CO ₂
Sensor technology	Electrochem.	Electrochem.	Electrochem.	Electrochem.	PID	NDIR
Measuring range	n.a	n.a	n.a	n.a	n.a	n.a
Sensor provider	Alphasense	Alphasense	Alphasense	Alphasense	Alphasense	Alphasense
Sensor type	CO-A4	NO-A4	NO ₂ -A42F	OX-A421	PID-AH	IRC-AT

1.1.3 Ateknea LEO

LEO units from Ateknea (Little Environmental Observatory) are battery-driven mobile platforms. These compact units measure three gaseous components (nitric oxide, ozone and nitric dioxide) as well as temperature, relative humidity and atmospheric pressure. Sampling rate can be defined by user (as short as 5s). Table 3 displays specifications for its gas sensors. The unit is designed as a highly portable unit communicating in real-time with a smart-phone via Bluetooth. The necessary smart-phone app was not available during the test period. A micro-USB output allows data transfer to a PC. Battery capacity allows 8-hour sampling runs.

This is the second version of Ateknea's portable unit.

Table 3: Ateknea node gas sensing specifications

Gas	NO	NO ₂	O ₃
Sensor technology	Electrochemical	Electrochemical	Electrochemical
Measuring range	n.a	n.a	n.a
Sensor provider	Alphasense	Alphasense	Alphasense
Sensor type	NO-A4	NO ₂ -A42F	OX-A421

1.1.4 Airbase CanarIT

The units measure as many as six gaseous components (carbon monoxide, carbon dioxide, nitric oxide, ozone, nitric dioxide and VOC) as well as temperature, relative humidity and atmospheric pressure. A noise sensor are also available on these units. The original plan was to use two different configurations, one dedicated to outdoor use, one to indoor measurements. Table 4 gathers information relevant for our tests. An integrated GPRS modem allows data transfer to Airbase server. Data are available on a user-friendly dedicated web-site.

Table 4: Airbase CanarIT node gas sensing specifications

Gas	CO ₂	NO	NO ₂	O ₃	CO	VOC
Sensor technology	NDIR	Electrochemical	MOx	MOx	n.a	PID
Measuring range	n.a	n.a	n.a	n.a	n.a	n.a
Sensor provider	n.a	n.a	n.a	Aeroqual	n.a	n.a
Sensor type	n.a	n.a	n.a	n.a	n.a	n.a

1.1.5 CVUT

The units measure four gaseous components (carbon monoxide, tot VOC, sulfur dioxide and nitric dioxide) as well as temperature, relative humidity and atmospheric pressure. Table 5 gathers gas sensor specifications for the unit.

Table 5: CVUT unit gas sensor specifications

Gas	CO	NO ₂	SO ₂	Tot VOC
Sensor technology	Electrochemical	Electrochemical	Electrochemical	PID
Measuring range	n.a	n.a	n.a	n.a
Sensor provider	Alphasense	Alphasense	Alphasense	Alphasense
Sensor type	n.a	n.a	n.a	n.a

1.1.6 Dunavnet

The Dunavnet units measure six gaseous components (carbon monoxide, nitric oxide, ozone, nitric dioxide, sulfur dioxide and carbon dioxide) as well as temperature, relative humidity and atmospheric pressure. Table 6 gathers information relevant for our tests on the units. An integrated GPRS modem allows data transfer to Dunavnet's server. Data are available on a user-friendly dedicated web-site.

Table 6: Dunavnet unit gas sensor specifications

Gas	CO	NO	NO ₂	O ₃
Sensor technology	Electrochemical	Electrochemical	Electrochemical	Electrochemical
Measuring range	0-5000 ppb	0-2000 ppb	0-200 ppb	0-200 ppb
Sensor provider	Alphasense	Alphasense	Alphasense	Alphasense
Sensor type	n.a	n.a	n.a	n.a

1.2 Field assessment of sensor platforms

Four platforms were evaluated under ambient conditions by comparing measurements with reference instruments at UCAM over varying length of time ranging days to months. These platforms include 1 × CVUT node, 1 × Geotech node, 2 × AS units and 2 × Ateknea nodes. All the platforms measured a range of gas species including carbon monoxide (CO), nitric oxide (NO), nitrogen dioxide (NO₂), ozone (O₃) / total oxidant or sum of NO₂ and O₃ (O_x) and carbon dioxide (CO₂). The Geotech

node also measure particulates (PM). Meteorological data like temperature, relative humidity (RH) and pressure are also recorded by some of the units. Except for the Ateknea nodes which are intended for personal exposure studies, the rest of the platforms were designed to be deployed as static nodes both indoors (AS) and outdoors (Geotech and CVUT).

1.2.1 Cambridge Field Instrumentation

The team at UCAM have setup a monitoring station comprising a suite of reference and equivalent instrumentations for continuous outdoor measurements of toxic and greenhouse gases, particulates and meteorological parameters. This monitoring site has been running for over a year now from first quarter of 2014. Except for the weather station and particulate instrument which are both located outdoors, all other instruments are housed indoors. All measurements are made on the roof of the Chemistry Department building in Cambridge UK (52.19761 N and 0.12529 E), located in the city centre close to a quiet road. Although the sampling inlet is approximately 22 m above mean sea level, long-term measurements will be influenced by both local and regional emissions. Table 7 below summarise the instruments used for the measurement of gases, particulates and weather at UCAM.

(a) Gas species measurement (indoor instrumentation)

Outdoor air is pumped through polyvinylidene fluoride (PVDF) inlet manifold (fig. 1 (b)) from which each analyser samples air via fluorinated ethylene propylene (FEP) inlet. Data are reported as 1 minute average and in the sampling mode the blue line in the schematics in fig. 1(a) is in use. Zero and span calibration (red lines in fig. 1(a)) are done daily just after mid-night, these data are subsequently used for ratification of the raw measurements. A standard gas cylinder mix containing 201 ppm CO ($\pm 2\%$) and 20.9 ($\pm 2\%$) ppm NO from Air Liquide, UK was used for laboratory calibration. A dynamic gas calibrator (Thermo Scientific Model 141i) was used to dilute the high concentration CO and NO gas using zero gas generated from Thermo Scientific Model 111 Zero Air Supply. Zero gases generated contain < 0.1 ppm (CO and hydrocarbons), < 0.8 ppb (O_3) and < 0.5 ppb (NO, NO_2 , SO_2 , H_2S and NH_3). All the analysers (table 7) are serviced annually to ensure the desired precisions and accuracies are still achieved.

Table 7: Instrumentation for gas species, particulates and weather.

Instrument type	Instrument	Measurement method	Detection limit
CO analyser	Thermo Scientific [®] Model 48i CO Analyser	IR absorption, GFC	40 ppb
NO-NO ₂ -NO _x analyser	Thermo Scientific [®] Model 42i-NO-NO ₂ -NO _x	Chemiluminescence	0.40 ppb
O ₃ analyser	Thermo Scientific [®] Model 49i O ₃ analyser	UV photometric	0.50 ppb
SO ₂ analyser	Thermo Scientific [®] Model Model 43i SO ₃ analyser	Pulsed fluorescence	< 0.5 ppb
Zero Air Supply (For NO, NO ₂ , O ₃ , SO ₂ and CO)	Thermo Scientific [®] Model Model 111 analyser	Filter, scrubber, activated and heated reactor	N.A.
Dynamic calibrator	Thermo Scientific [®] Model Model 146i analyser	MFC (0 – 1000 sccm) Output (0 – 10,000 sccm)	N.A.
CO ₂ and CH ₄ analyser	Picarro [®] G2201-i analyser	CRDS	200 (¹² C) for CO ₂ 10 (¹³ C) for CO ₂

Instrument type	Instrument	Measurement method	Detection limit
			50 (¹² C) for CH ₄ 10 (¹³ C) for CH ₄
Particulate instrument (PM _{1.0} , PM _{2.5} , PM ₄ and PM ₁₀)	Fidas [®] 200 S	optical aerosol spectrometer: light Lorenz-Mie light scatter	
Weather station (wind speed, wind direction, temperature, humidity, pressure and precipitation)	Lufft [®] WS 600 Met station		±0.2°C (-20 to 50°C) ±2% RH ±1.5 hPa (pressure) ±3°(WD) ±0.3 ms ⁻¹ (WS) 0.01 mm (precipitation)

(b) Particulate and weather station (outdoor instrumentation)

Both the particulate and weather instruments are located outdoors (fig. 2) close to the inlet manifold that supplies the gas analysers. Data from these two instruments are also reported as 1 minute averages with same timestamp as the gas measurements. This will allow comprehensive data analysis using varying environmental factors on all the gas species monitored. Field comparison can be done using test chamber located indoor (fig 1. (b)) or by mounting weather-proof instruments outdoors (e.g. Geotech pods fig 2). Figures 3 and 4 show example of a year and a week data recorded respectively by the gas analysers, PM instrument and weather station.

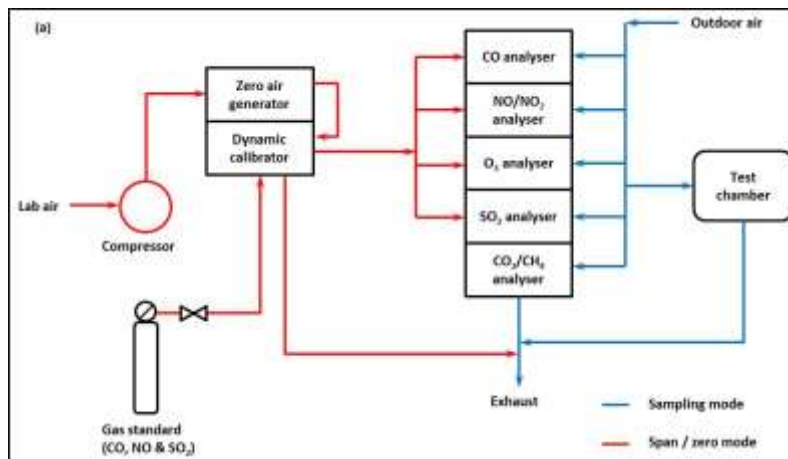

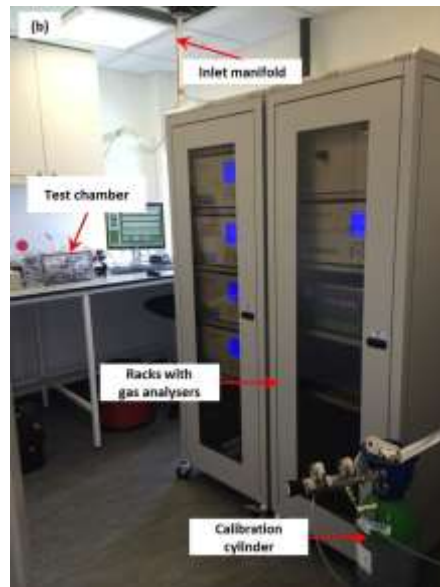

Figure 1. Layout of gas measurement (a) and actual setup of instrument suite (b).



Figure 2. Weather station, particulate instrument and inter-comparison instruments (Geotech pods and UCAM SNAQ boxes). Note the UCAM are prototype air quality instruments developed independently at University of Cambridge and is not part of CITI-SENSE project.

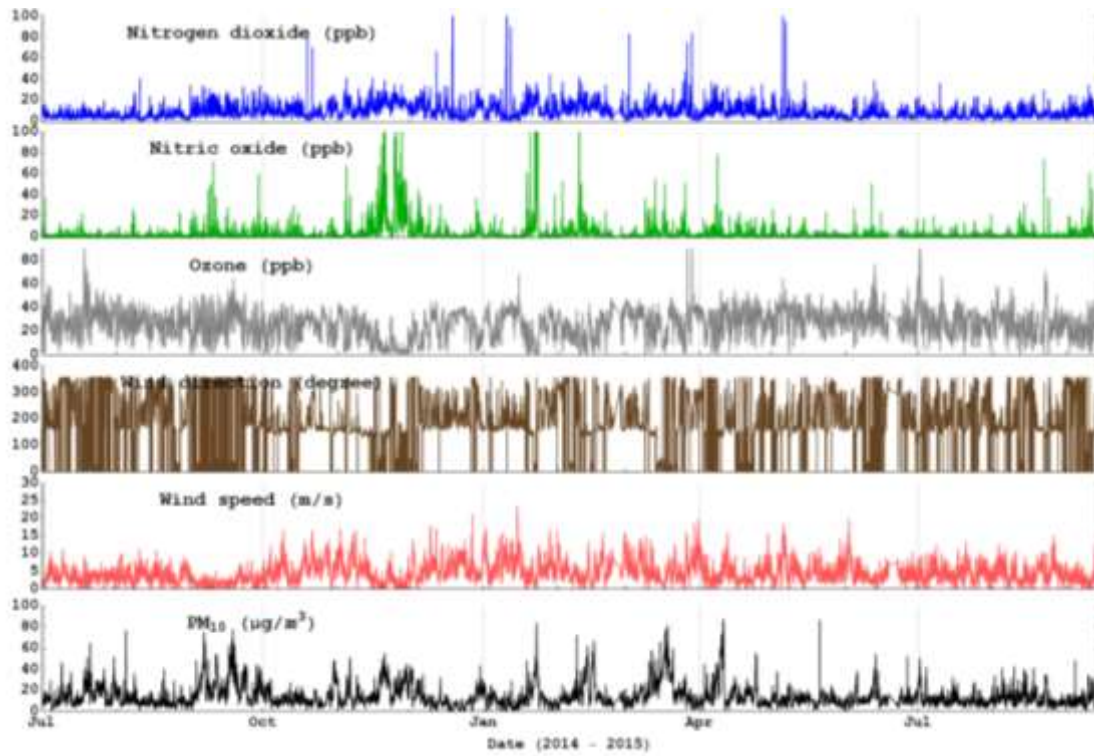

Figure 3. Time series of outdoor NO, NO₂ and O₃ mixing ratio, PM₁₀ and wind measurements over a period of one year (July, 2014 to September, 2015).

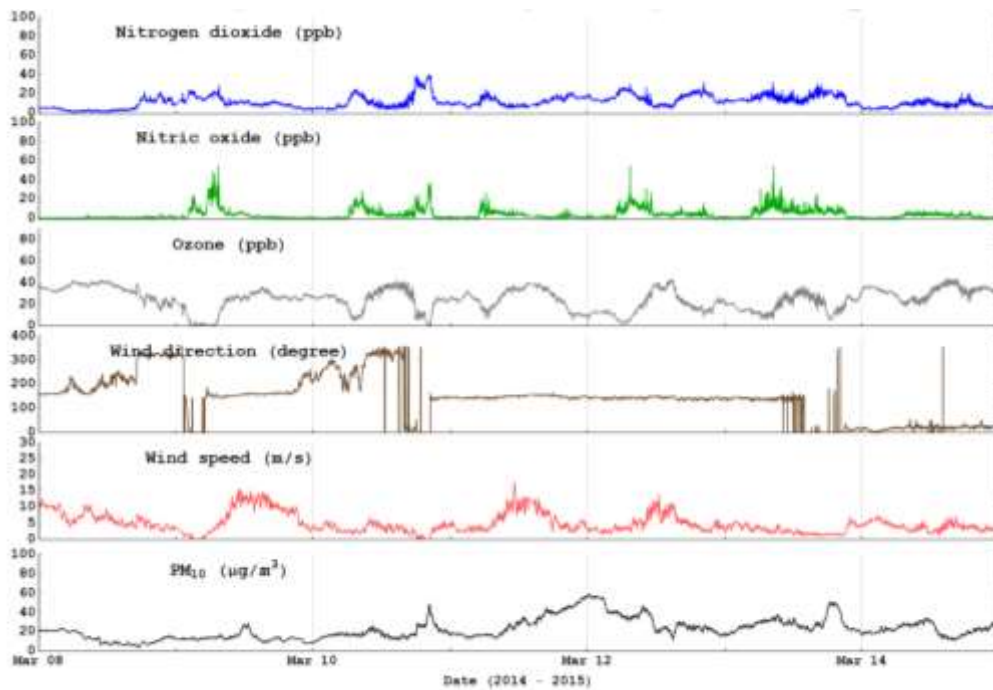
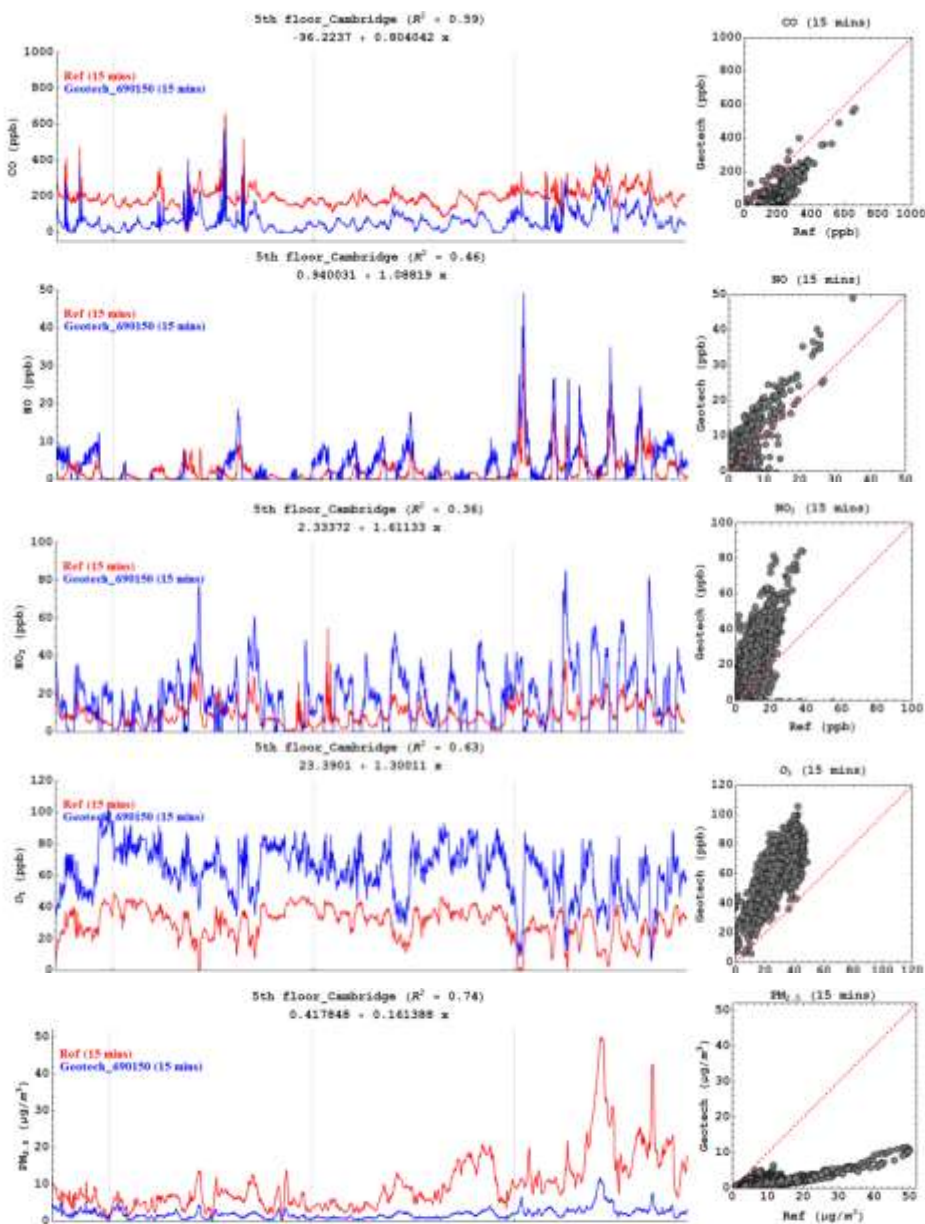

Figure 4. One week data (8 – 14 March, 2015) of outdoor NO, NO₂ and O₃ mixing ratio, PM₁₀ and wind measurements.

1.2.2 Field assessment: Geotech / AQMesh pod

Although three Geotech pods (two old and one newer model) are currently being tested, results presented here will be from the latest pod. It was received by UCAM in mid-February 2015 for field test. This unit measures gas species including CO, NO, NO₂ and O₃ as well as particulate matters (PM count, PM_{2.5} and PM₁₀). The pod also recorded RH, temperature and atmospheric pressure. Data are reported as 15 minutes averages. Except for PM₁₀ ($R^2=0.5$), overall there was good correlation ($0.74 < R^2 < 1$) for non-gaseous measurements (PM_{2.5} and meteorology data). CO and O₃ comparison showed relatively good correlation with $R^2 \sim 0.6$ (figure 5 and table 2). Although the gradients of the PM measurements are very low, the good correlations indicate the data can be retrospectively calibrated using a single correction factor. NO₂ shows poor correlation with the reference measurement with $R^2=0.36$ and gradient of 1.6.



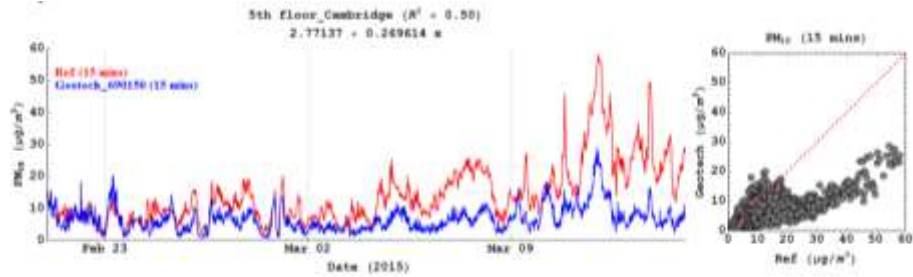
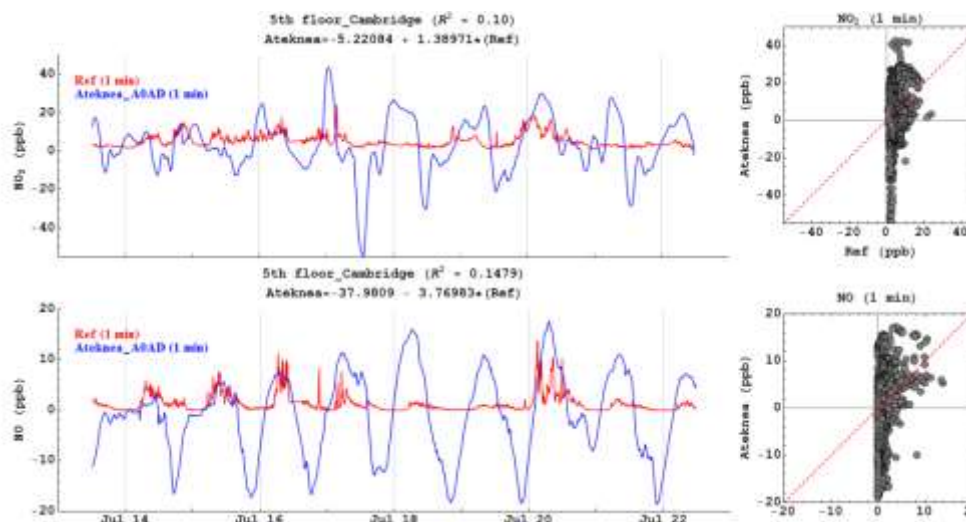

Figure 5. Time series and correlation plots of CO, NO, O₃ and NO₂ mixing ratios as well as PM₁₀ concentrations from the reference instruments and a Geotech pod. Data covers 23 days (21 February to 15 March, 2015).

1.2.3 Field assessment: Ateknea units

Two prototype Ateknea personal monitors (A0AD and 9D3B) are currently being studied in Cambridge. These units are not designed to be weatherproof hence were deployed in weatherproof enclosures for this comparison. Parameters recorded include NO, NO₂ and O₃ as well as temperature and RH at sampling rate of 20 s (user defined). Figure 6 indicates the mixing ratio over the comparison period were very low at the sampling site making it challenging to conduct meaningful comparison. In addition, there was non-systematic clock drift in the Ateknea units which may also explain the poor correlation, especially for O₃, RH and temperature where the time lag between the reference and Ateknea node is obvious (fig. 6 – 7).



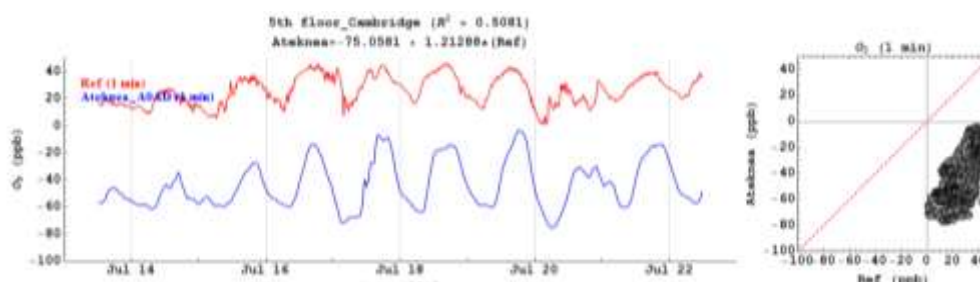

Figure 6. Time series and correlation plots of NO₂, NO, and O₃ mixing ratios measurements from the reference instruments and one of the Ateknea nodes. Data covers 10 days (13 – 22 August, 2015).

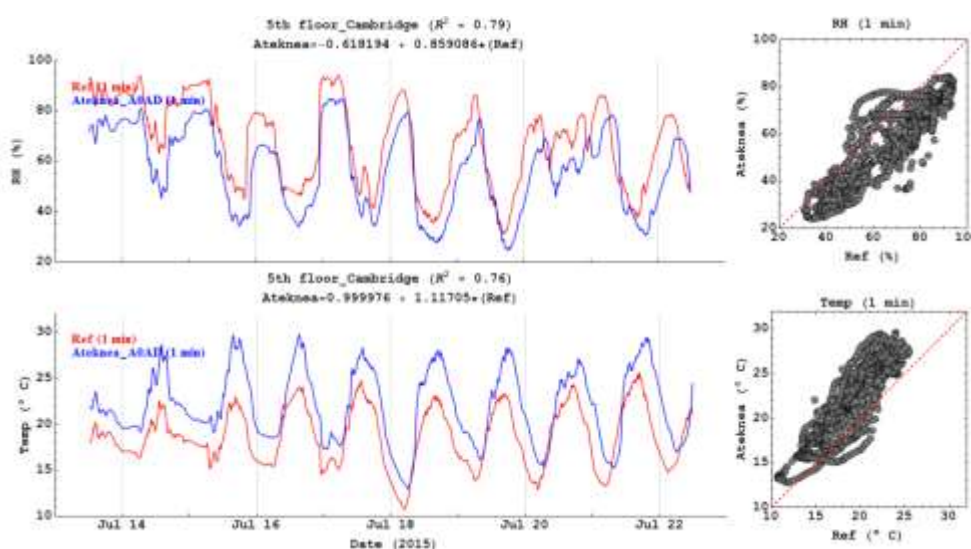

Figure 7. Equivalent plots to figure 6 for temperature and RH measurements.

1.2.4 Field assessment: Atmospheric Sensor nodes

Two AS units (node 20 and 24) have been assessed outdoors in Cambridge since 30th May 2015. This platform measures CO, NO, NO₂, O₃, total VOCs and CO₂. Other parameters include temperature, RH, sound and particulates (PM₁, PM_{2.5} and PM₁₀). Data from these units are recorded every 5 minutes and comparison will be on this time scale. Unlike the Geotech pod, the AS units provides both the raw data in volts and the on-board converted data for the toxic gas measurements based on Alphasense algorithm. There is added advantage that once a final algorithm has been agreed, historical raw data can be re-analysed. The gas measurements comparison presented in this section are based on conversion using UCAM generated algorithm (compare to fig. A4) which AS will attempt to reproduce on their units. Figure 8 shows the time series and correlation plots for CO, NO, NO₂, O₃ and CO₂. There is good correlation for O₃ (0.7) and to some extent CO (0.42) and to a lesser extent for NO (0.33). However the NO₂ and CO₂ measurements show low correlation with R² of respectively 0.26 and 0.20. Similarly, the PM correlations were poor especially for PM₁₀ with R² of 0.14 as presented in table 2.

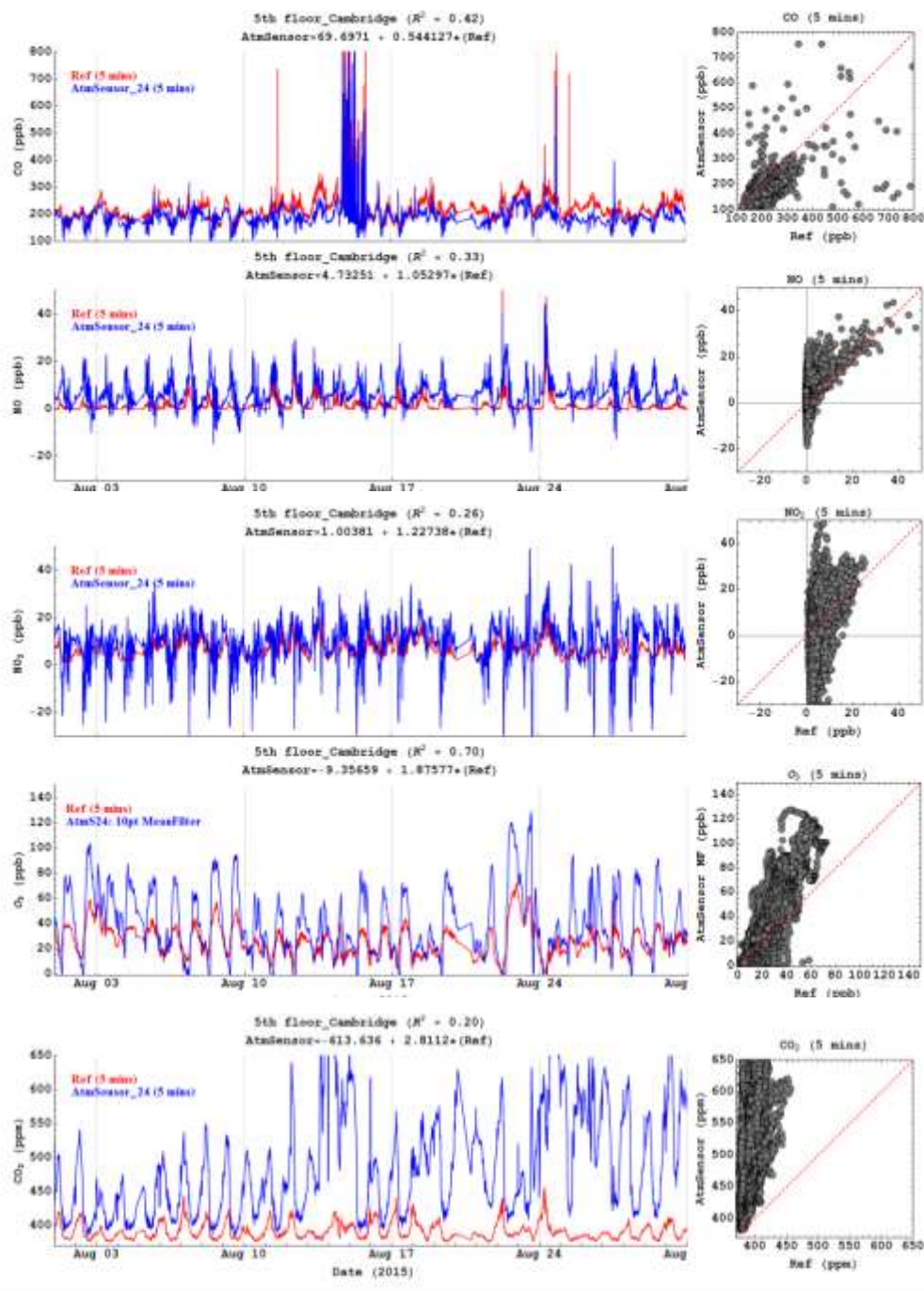

Figure 8. Time series and correlation plots of CO, NO, NO₂, O₃ and CO₂ mixing ratios from the reference instruments and one of the Atmospheric sensor nodes. Data covers 31 days (1 to 31 August, 2015). Data produced using UCAM algorithm.

1.2.5 Field assessment: CVUT node

Although CVUT units were not eventually selected as part of the final platforms to be used in the project, we have included it here in this report because it was fully assessed for ambient performance at UCAM. This unit is not weather proof and was therefore deployed in a test chamber (fig. 1b) indoors with common sampling inlet as the reference measurements. The CVUT instrument measured gas species including CO, NO₂, SO₂ and total volatile organic compounds (VOCs), as well as ambient temperature at a time resolution of approximately 14 s. These data were averaged to 1 minute resolution in order to match them up to the reference data which has time resolution of 1 minute. All gas measurements were compared with reference measurements except VOCs which is not measured at the reference station. Temperature measurements were also excluded from the comparison as the CVUT measurements were representative of laboratory rather the outdoor temperature recorded by the reference meteorology station. Fig. 9 shows CO, SO₂ and NO₂ time series and correlation plot of the mixing ratios for a month data (1 – 30 November) during the comparison period from September to December 2014. Except for CO with relatively good correlation ($R^2=0.66$) the comparisons were poor for the other gas species. Several factors may account for the observation including low mixing ratio measurements at the site especially for SO₂ which are generally below 5 ppb. It is also possible that there were gas losses on the inlet system, reducing values of the comparison. However the NO₂ measurements from the CVUT are over estimating the true measurements as shown in the summary in Table 2.

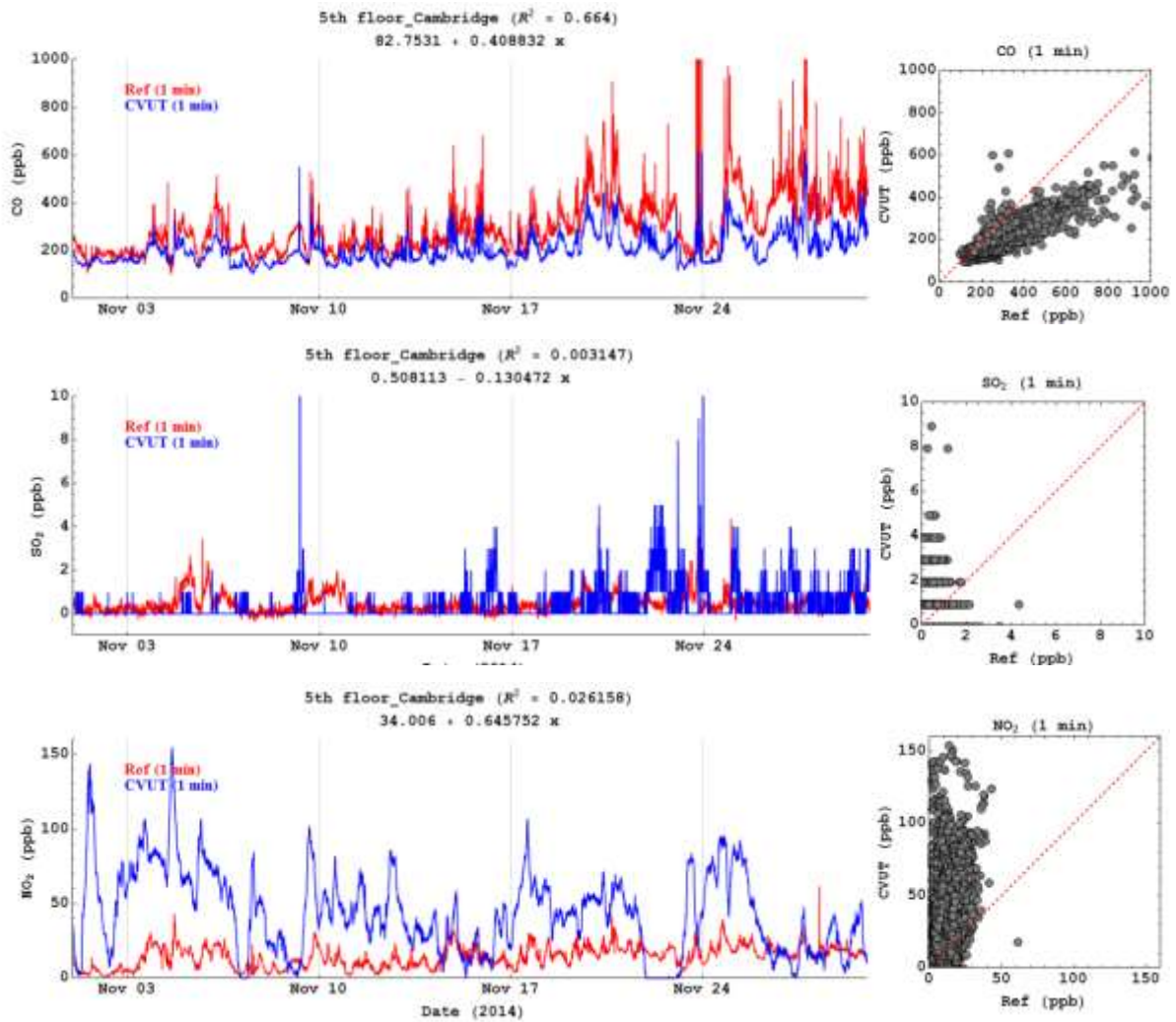

Figure 9. Time series and correlation plots of CO, SO₂ and NO₂ mixing ratios from the reference instruments and a CVUT node. Data covers 30 days (1 to 30 November, 2014).

1.2.6 Overview of field performance of the platforms

In this section we review the overall field performance of the different platforms assessed at UCAM with the aim of commenting on the potential and capabilities of these platforms for use in atmospheric measurements.

Table 8 summarise the statistical data of the field comparison for all parameters compared for each platform with measurements at UCAM monitoring station. We found that all platforms were able to reproduce meteorological measurements like RH, ambient temperature and atmospheric pressure (when measured) to within 5 – 20% of the reference measurements. However the performance was different for gas and particulate measurements. We observed some agreements for CO ($R^2 = 0.42 - 0.66$) and NO ($R^2 = 0.15 - 0.46$) and encouraging results for O₃ ($R^2 = 0.51 - 0.70$) all subject to proper re-calibration of the data. NO₂ ($R^2 = 0.1 - 0.36$) showed the least correlation with the reference measurements. While the NO₂ sensors show good performance under controlled conditions (as presented in the laboratory data comparison evaluation at NILU see section 1.2), these results reinforce the challenges in reproducing such level of performance in ambient condition. It should be mentioned that the mixing ratios at the monitoring station for NO₂ were often low generally below 40 ppb making any error associated with temperature more significant at these levels. Previous studies in Cambridge 2009 and more recently at London Heathrow airport using similar electrochemical sensors close to ground level have shown good agreement ($R^2 = 0.8 - 0.9$) for O₃ corrected NO₂ data. Thus with improved temperature compensation algorithm on these new generation NO₂ sensors, there is strong indication that acceptable indicative NO₂ measurements at street levels can be achieved with these platforms. The PM measurements were overall encouraging in the Geotech units especially for the number concentrations. In contrast, there is a strong indication that the PM measurements in the AS nodes are affected by RH which results in poor correlation ($R^2 = 0.14 - 0.31$) with the reference data. Though the current measurements can be used to indicate relative PM exposures, efforts have to be put into compensating for this effect to possibly extract quantitative PM information. CO₂ data were only measured by the AS nodes, though there appears to be strong baseline and sensitivity drift with time (see supplementary figure A2 in annex), these can be quantified and the data retrospectively corrected. In addition, the plan is to deploy the AS nodes indoors as part of the project where relatively high changes in CO₂ measurements (100s of ppm) will be recorded compared the ambient data presented here in these comparisons. At these relatively high CO₂ levels the errors highlighted above become less significant. We aim to access the reproducibility in the pair of CO₂ sensors been assessed in UCAM, once this is quantified we can generate a generic sensitivity correction algorithm which can be applied to all the CO₂ measurements made by the AS sensor nodes.

Table 8. Summary of linear fit metrics for three platforms (Geotech, Ateknea, Atmospheric and CVUT sensor nodes) when compared to reference measurements. Note the linear fit is of the form: $[\text{Parameter}]_{\text{platform}} = ([\text{Parameter}]_{\text{reference}} * \text{gradient}) + \text{intercept}$

Platform	Duration of comparison (days)	Species/parameter	Pearson correlation (R ²)	Gradient	Intercept	Data Average Time (minutes)
Geotech	23	CO	0.59	0.80	-96 ppb	15
		NO	0.46	1.10	0.94 ppb	
		NO ₂	0.36	1.61	2.33 ppb	
		O ₃	0.63	1.30	23.3 ppb	
		Temperature	0.97	1.11	-0.85 °C	
		RH	0.96	0.78	14.8 %	
		Pressure	1.00	0.99	7.68 mBar	
		PM _{2.5}	0.74	0.16	0.42 µg/m ³	
		PM ₁₀	0.50	0.27	2.77 µg/m ³	
		PM count	0.74	0.006	0.425 N/cm ³	
Ateknea [†]	10	NO ₂	0.10	1.39	-5.22 ppb	10
		NO	0.15	-3.77	-38.0 ppb	
		O ₃	0.51	1.21	-75.1 ppb	
		RH	0.79	0.86	-0.62 %	
		Temperature	0.76	1.12	1.00 °C	
Atmospheric sensors [§]	31	CO	0.42	0.54	69.7 ppb	5
		NO	0.33	1.05	4.73 ppb	
		NO ₂	0.26	1.23	1.00 ppb	
		O ₃	0.70	1.88	-9.36 ppb	
		Total VOCs	NA [‡]	NA [‡]	NA [‡]	
		CO ₂	0.20	2.81	-613 ppm	
		Temperature	0.94	1.23	-2.73 °C	
		RH	0.96	1.14	-12.3 %	
		Sound	NA [‡]	NA [‡]	NA [‡]	
		PM ₁	0.31	2.45	-6.37 µg/m ³	
PM _{2.5}	0.31	5.45	-23.2 µg/m ³			
PM ₁₀	0.14	4.15	-20.4 µg/m ³			
CVUT	30	CO	0.66	0.41	83 ppb	1
		NO ₂	0.026	0.64	34 ppb	
		SO ₂	0.003	-0.13	0.5 ppb	

‡ There is no corresponding reference data for comparison, statistics represented as NA.

† Though the data here had been post processed by Ateknea to account for the time drift, the 2-minutes averaged data provided still present same issue. Ten minutes averaged data were used for the comparison with the reference station.

§ The atmospheric sensor EC data were calculated using UCAM algorithms rather than the new algorithms provided by Atmospheric Sensor

1.3 Laboratory assessment of sensor platforms

A full characterization of CITI-SENSE platforms was beyond the scope of our task. The main objective was to calibrate all units against traceable standards before field deployment. Our laboratory set-up allowed performing these tests in an environment with simple air matrix, where ambient conditions are reproducible and accurately controlled.

1.3.1 Laboratory set-up

The testing set-up is built around three separate exposure chambers made of Pyrex glass. Figure 10 shows a rough schematic of the system, including one chamber only for the sake of simplicity. All part of pneumatic circuit between gas generation component to chamber outputs are made of either PTFE or glass. A thermostatic bath (Figure 11) provides a good thermal stability, even for long-term experiments. The latter is thermo-regulated by two dedicated heaters.

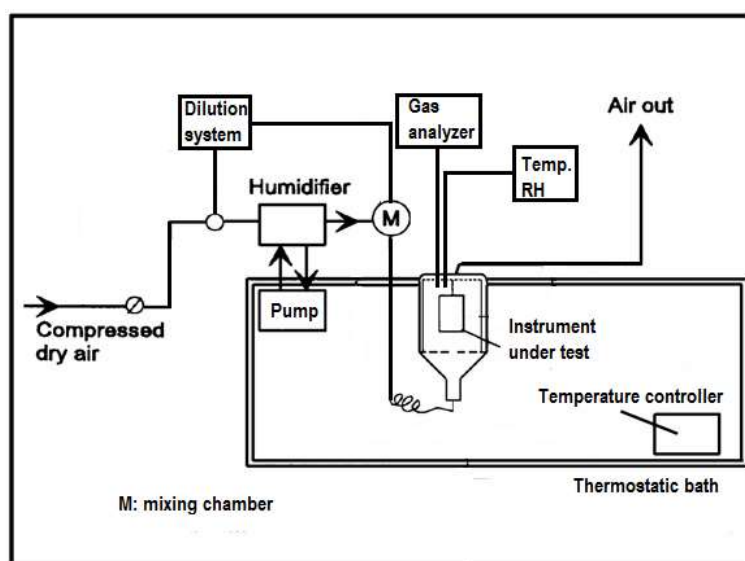

Figure 10: Set-up description

All generated test gases run through rudimentary heat exchangers which are immersed in the bath. Relative humidity can be precisely regulated within a large range. A dedicated mixing chamber (M on figure 10) is connected to incoming sample gas and to vapour-saturated air provided by a humidifier. Regulation of each incoming flow allows a relatively accurate and steady control of the final sample relative humidity. Both temperature and relative humidity were accurately monitored in each chamber by dedicated ozone-resistant sensors. Temperature was kept constant as much as possible, between 20°C and 25°C, with relative standard deviation below 1% during testing sequence. Relative humidity was set around 30%, with RSD below 1% during each testing sequence. No particular flow restriction can be found in the set-up and it is therefore assumed all measurements took place at atmospheric pressure in the testing chambers. The latter was not monitored but it is assumed that pressure has little effect on the sensors.

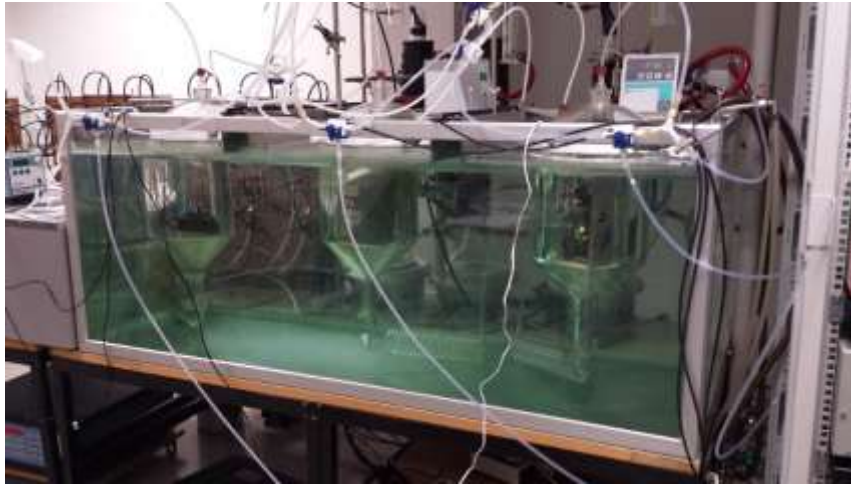

Figure 11: Laboratory set-up: measurement chambers in thermostatic bath

A standard dilution system generates all necessary samples by diluting traceable primary gas standards (NO and CO) with 0-air. The calibrator is equipped with a UV lamp-based O₃ generator and a photometer which enables accurate O₃ production. NO₂ is generated by mixing O₃ and NO in a borosilicate glass chamber inside the calibrator (Gas Phase Titration). Testing gases can be generated with different concentrations in a relatively large range, only limited by concentration level of reference gas cylinder and mass flow controller ranges.

All gas measurements were performed by CEN approved analysers. Table 9 gathers all information regarding all used instrumentation. Gas analyzers were connected on the output of measurement chambers (blue valve on figure 11). They were regularly calibrated by connecting them directly to the gas calibrator.

Table 9: Laboratory instrumentation

Instrument type	Instrument	Measurement method	Detection limit / Accuracy
CO analyzer	Teledyne API 300E	Non-dispersive IR spectroscopy (EN14626)	40 ppb/
NO _x analyzer	Teledyne API 200A	Chemiluminescence (EN 14211)	0.4 ppb
O ₃ analyzer	Teledyne API 400	UV photometry (EN14625)	0.4 ppb
SO ₂ analyser	Teledyne API 100A	UV fluorescence (EN14212)	0.4 ppb
Zero Air Supply (For NO, NO ₂ , O ₃ , SO ₂ and CO)	Custom-made	Filter, scrubber, activated and heated reactor	N.A.
Dynamic calibrator	Teledyne API 700	MFC (0 – 1000 sccm/0 - 50 sccm) Output (0 – 10,000 sccm)	N.A
Temperature sensor	Rotronic Hygroclip2-S	Pt100	N.A / 0.1% (@0° C)
RH sensor	Rotronic Hygroclip2-S	Hygromer	N.A. / 0.8% (@23° C)

1.3.2 Test protocol

The test protocol consists of a multi-point calibration involving five different gas levels plus zero-air. Concentration step changes (see table 10) are performed at constant temperature and relative humidity.

1.3.2.1 Response time

When generating gas samples, obtaining a constant concentration in the chamber requires several flushings of the pneumatic system. The set-up displays an intrinsic lag-time depending on total volume from the pneumatic system and gas flows produced by the gas calibrator and the humidifier. Our testing configuration led to relatively long lag time, i.e. a slow system that is not suitable for evaluating t_{90} response times for the different studied sensors. However, it was possible to evaluate the time needed for the platforms to generate 90% of final concentration after concentration level change with our system. This time was below 15 minutes for all tested sensors and gas species.

1.3.2.2 Calibration

The multi-point calibration process involves calibration steps lasting 90min, i.e. at least 6 times the interval needed to reach 90% of final concentration. Step changes were performed as per the following order: 0, 4, 2, 0, 3, 1, 5 and 0.

Due to its high chemical reactivity, O_3 was absorbed at the surface of all platforms when tested. This presented a challenge when it comes to O_3 concentration stability under the test. Due to its relatively low measuring range (0-5ppm) and for practical reasons, the CO sensor from the AQMesh node was calibrated manually (see CO low column)

Table 10: Concentration levels during tests

Test gas Set-points	CO low [ppb]	CO [ppm]	NO [ppb]	NO ₂ [ppb]	O ₃ [ppb]
1	1.5	5	100	50	45
2	2	10	200	80	90
3	3	15	300	90	135
4	4.5	20	400	100	180
5	5	23.8	475	120	200

Results showed that all tested devices displayed a linear response. The results are evaluated by calculating linear regression function line for measured points and correlation coefficients between relevant data sets. The data sets did not include measurements done with other gases present. Measurements performed at the beginning of a step change (first 15 minutes) during calibration sequence were done during a transitional state when it comes to gas concentrations present in the chambers (lag-time mentioned earlier). All values measured during these periods were therefore not considered for the correlation estimation.

1.3.2.3 Repeatability

Repeatability was evaluated by considering measurements performed during several periods lasting one hour each, in the course of the multi-point calibration. Standard deviations were calculated with values obtained while measuring with 0-air and with one concentration value. The calculation concerned values measured with both reference analysers and platform sensors. Results obtained with reference instruments give an idea about gas production stability.

1.3.2.4 Interference

Generation of one single gas at a time allows separate calibration of each sensor. It also provides information about cross-sensitivity issues since all platform micro-sensors are measuring simultaneously. Observed cross-sensitivity was reported with a simple scale including none (N), low (L) and high (H). Some data series presented in annex show existing cross-sensitivity issues.

It must be noted that NO₂ production via gas phase titration left a few ppb O₃ as reaction by-product.

1.3.3 Results

Result graphs presented in the following are mostly based on data series that can be found in the annex of the report. A correlation graph was generated for each calibrated sensor, provided data quality of measurements was sufficient to produce useful information.

1.3.4 Geotech AQMesh

Standard AQMesh units deliver one-hour averaged data. The measurement interval was set down to 15 min on this unit for testing purposes. Geotech sent two AQMesh units of an earlier type (121150 and 122150) to NILU prior to the pilot study. Results are not presented here. One unit of the latest AQMesh version was tested in the second phase of the project, in March 2015. Only one unit, 688150, was available for the first laboratory test. A second unit, 864150, was later tested with O₃, NO and NO₂. This test followed a three-week field calibration done in Oslo (see Oslo study below). Results from this co-location raised questions regarding performance of these three sensors. It was therefore decided to do a laboratory calibration of the sensors which had produced data poorly correlated to reference measurements in the field, especially for O₃ and NO₂. Results from this laboratory calibration showed good correlation between O₃ sensor and reference photometer. The NO₂ sensor showed no cross-sensitivity with O₃. However, the O₃ sensor reacted quite strongly with NO₂. (see dataseries from unit 864150 in annex). This might explain the poor behaviour of the unit in the field.

1.3.4.1.1 NO sensor

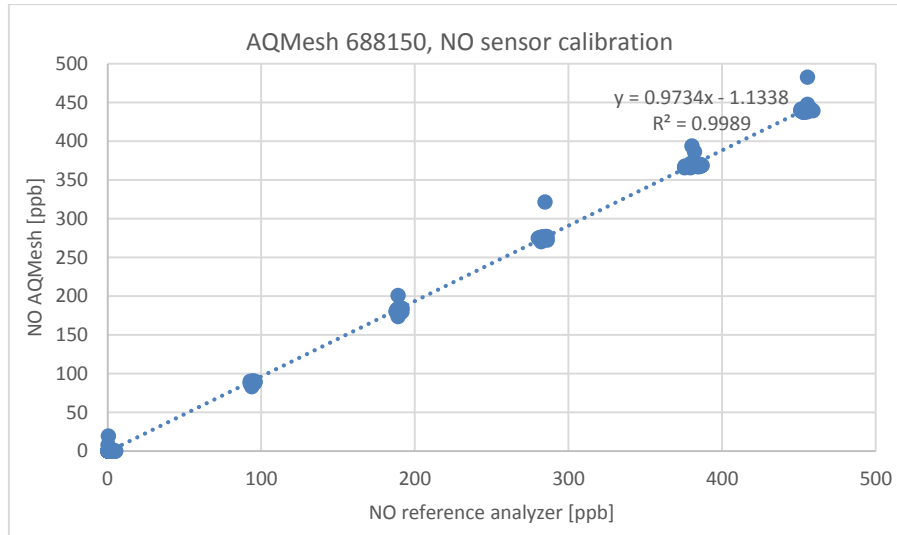

Fig. 12: NO laboratory calibration of AQMesh nodes

There was good correlation between tested sensor and reference analyzer. Some NO peaks up to 66ppb were generated erratically during O₃/NO₂ calibration sequences. There was no sign of correlation between these peaks and gas generation of other gases (NO₂, CO or O₃) which makes it difficult to draw conclusions regarding cross-sensitivity.

1.3.4.1.2 NO₂ sensor

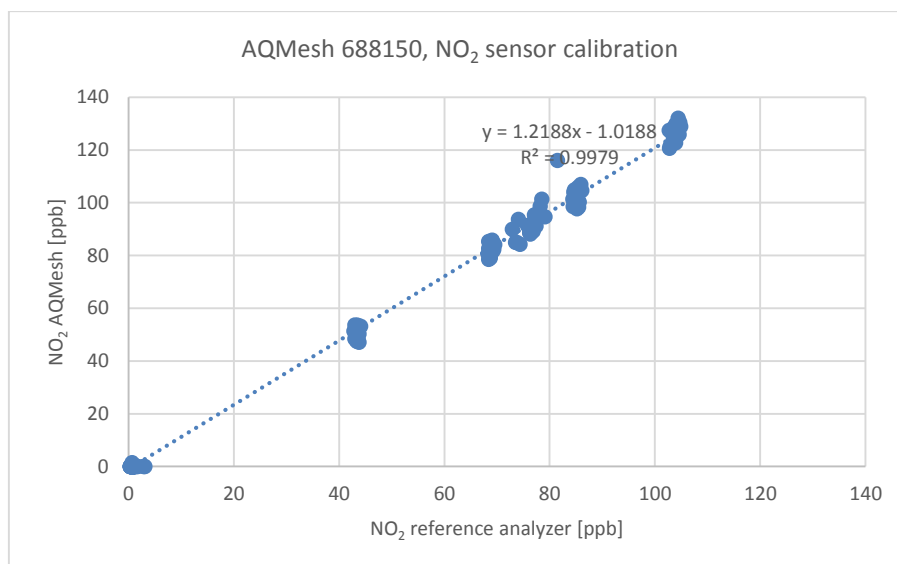

Fig. 13: NO₂ laboratory calibration of Geotech/AQMesh nodes

There was good correlation between tested sensor and reference analyzer. The sensor reacted with a low peak (ca. 7ppb) at the beginning of each O₃ calibration sequence, with O₃ set-point at 180ppb. It also reacted to NO, but only at the beginning of first NO calibration sequence.

1.3.4.1.3 O₃ sensor

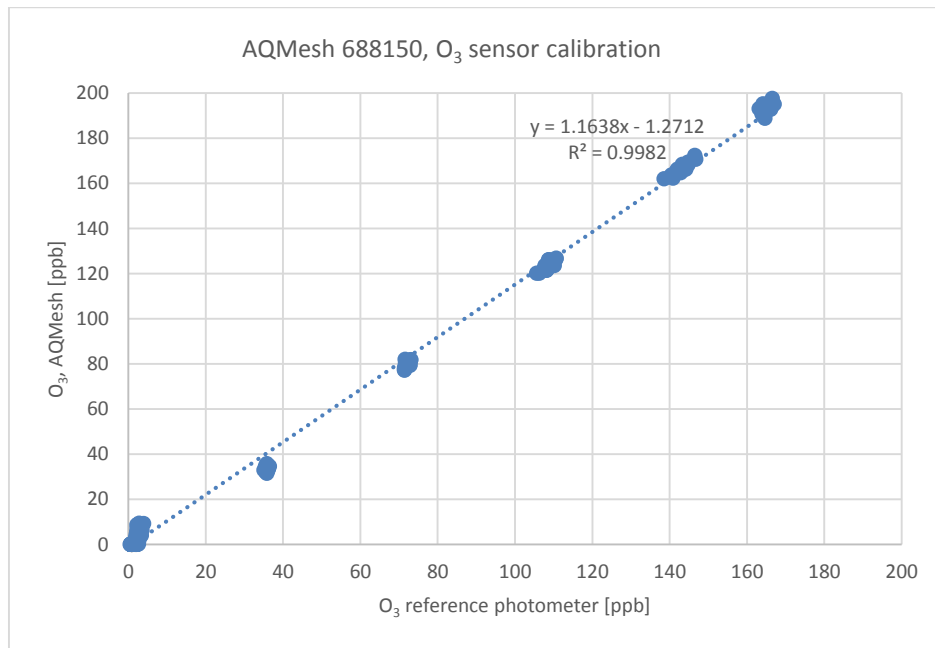

Fig. 14: O₃ laboratory calibration of Geotech/AQMesh nodes

There was good correlation between tested sensor and reference analyzer. Some signs of cross-sensitivity with NO₂ were observed on unit 688150. It was very clear on unit 864150.

1.3.4.1.4 CO sensor

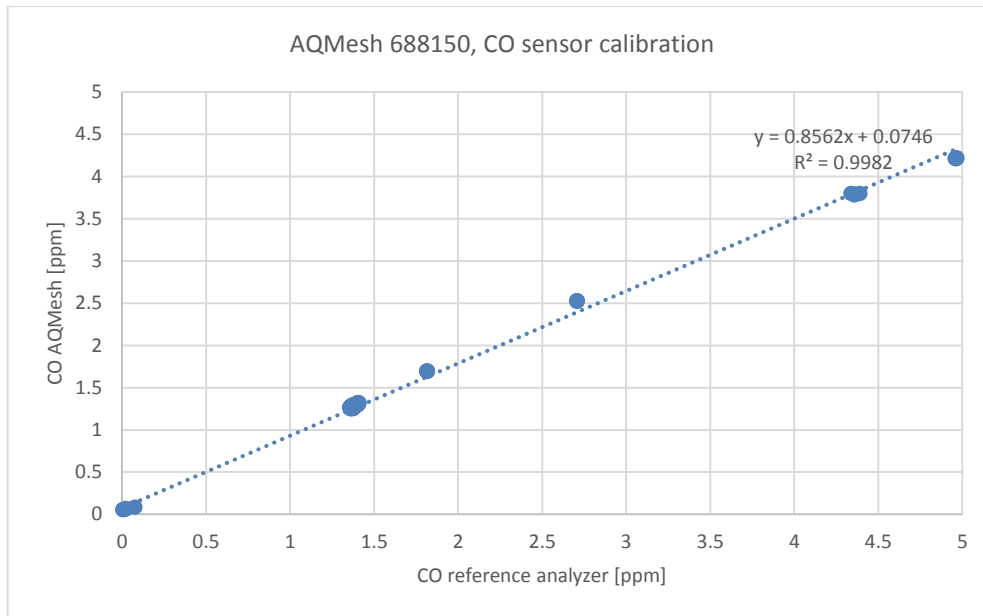

Fig. 15: CO laboratory calibration of Geotech/AQMesh nodes

There was good correlation between tested sensor and reference analyzer. CO gas generation at such low levels with our set-up required using the lowest part of MFC measuring range from the calibrator. The latter is not considered as a usable part of the range, implying higher uncertainty in the process.

Having mentioned this issue, there was a high correlation between reference and CO sensor data.

1.3.5 Ateknea LEO

Ateknea delivered two prototypes (unit 11 and 12) in June 2014. These were tested but results are not presented in the following. A re-designed unit was available in March 2015. Units 0X666B988D and 0X666BA0D4 were tested with a sampling rate of 10s. The timestamp displayed drifting issues which were solved with a later software version. The instrument software allows changes in slope and offset for each sensor. The instruments were calibrated without changing any of these parameters.

1.3.5.1.1 NO₂ sensor

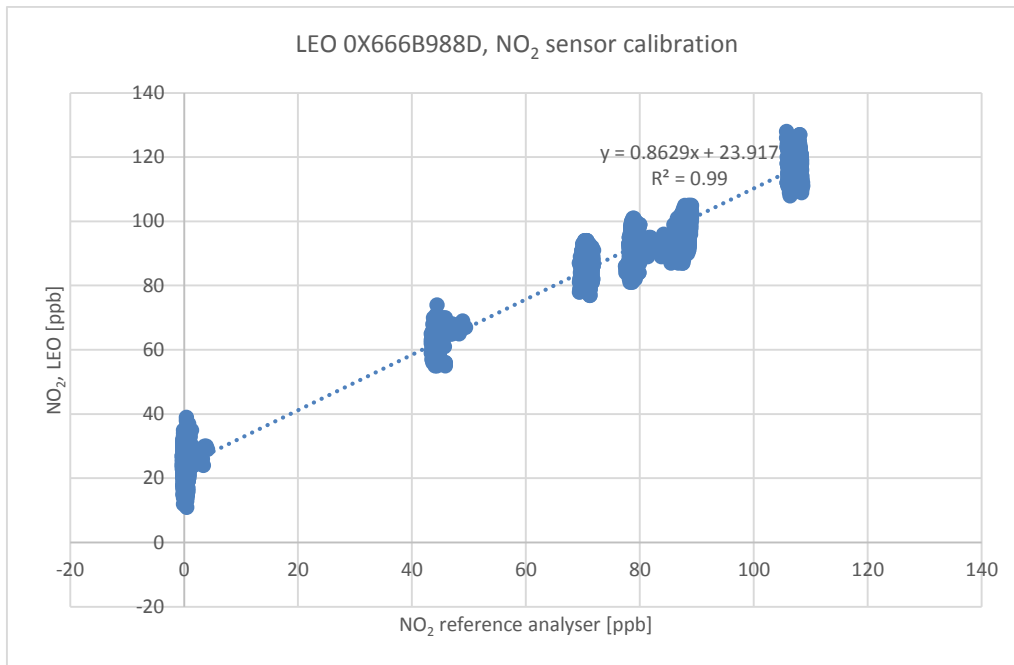

Fig. 16: NO₂ laboratory calibration of ATEKNEA unit

There was good correlation between tested sensor and reference analyzer. There are some spread in the recorded data, which cannot be attributed to gas generation instability. Standard deviation calculations displayed in table 12 clearly show relatively low standard deviation of reference measurements during span calibration. One must keep buried in mind that data is generated with a sampling rate of 10 s.

The NO₂ sensor did not react to neither O₃ nor CO relatively high concentrations.

1.3.5.1.2 O₃ sensor

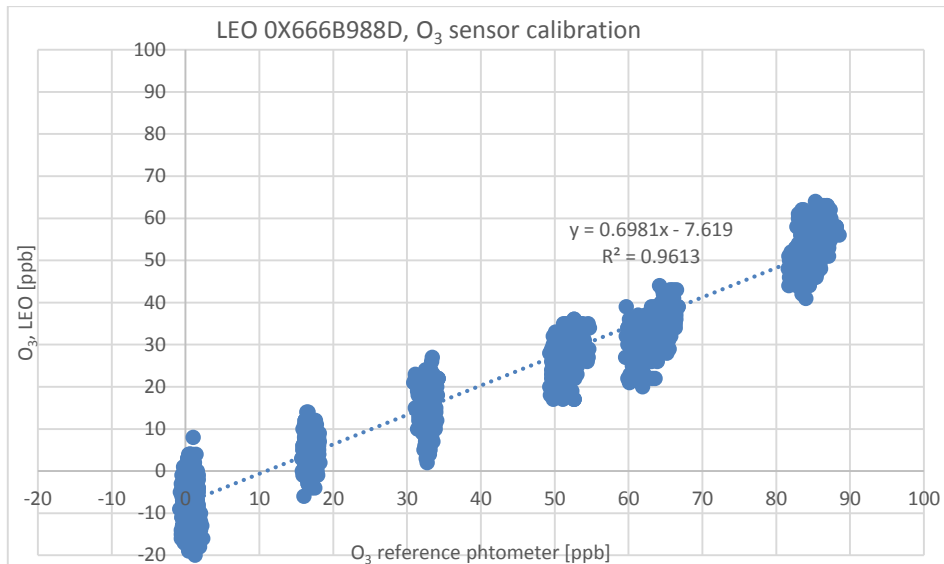

Fig. 17: O₃ laboratory calibration of ATEKNEA unit

There was good correlation between tested sensor and reference photometer. There are some spread in the recorded data, for the same reasons given above. It showed strong sensitivity to NO₂ (see relevant graph in annex).

1.3.5.1.3 NO sensor

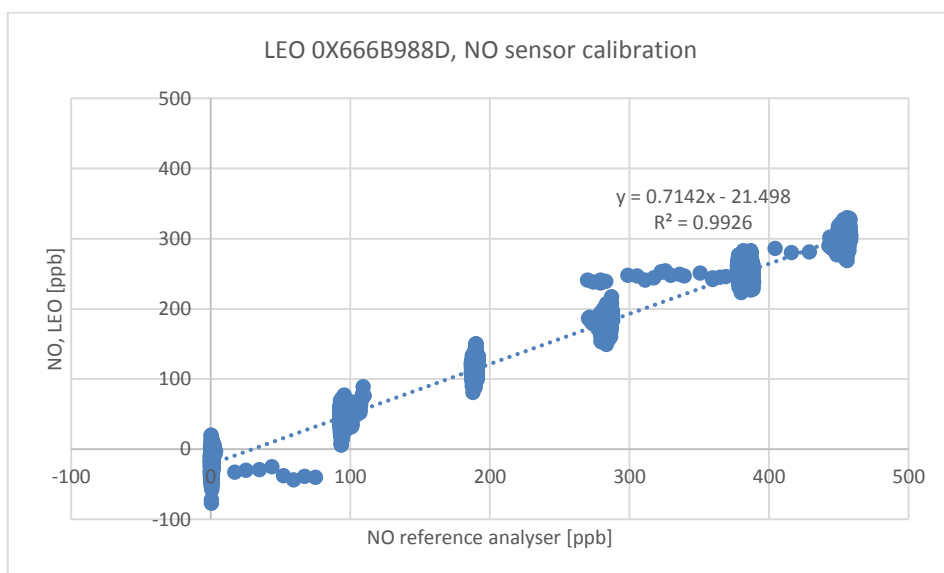

Fig. 18: NO laboratory calibration of ATEKNEA unit

Good correlation between tested sensor and reference analyzer. There are some spread in the recorded data, caused by the same reasons as the ones presented above. The NO sensor generated high negative peaks which were removed from the data series in order to allow data analysis.

1.3.6 Atmospheric Sensor node

Unit AS510.00114.0003 was received and tested in March 2015. A 5 minute sampling rate was used during the calibration. The laboratory set-up only allowed testing CO, NO, NO₂ and O₃ sensors.

1.3.6.1.1 O₃ sensor

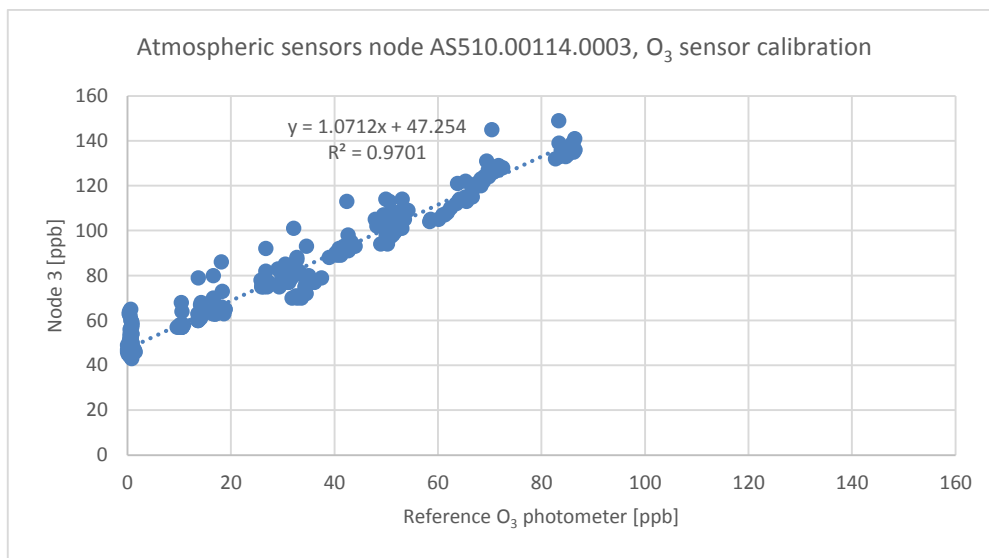

Fig. 19: O₃ laboratory calibration of Atmospheric node

Good correlation between tested sensor and reference photometer. The tested O₃ sensor presented a relatively noisy response, i.e. high peaks showing up in an erratic way. Most of these peaks were removed from the analysed data set. The tested unit was modified with a noise filter in a later version. The sensor showed high cross-sensitivity with NO₂. (see graph for O₃ sensor calibration feat. NO₂ in annex)

1.3.6.1.2 NO sensor

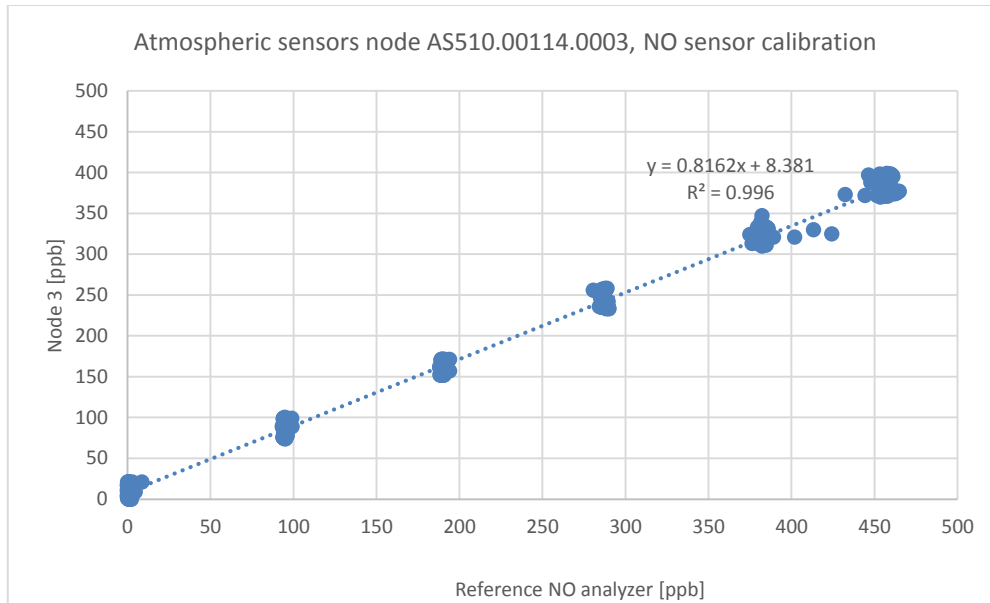

Fig. 20: NO laboratory calibration of Atmospheric node

Good correlation between tested sensor and reference analyzer. No cross-sensitivity to other tested gases.

1.3.6.1.3 NO₂ sensor

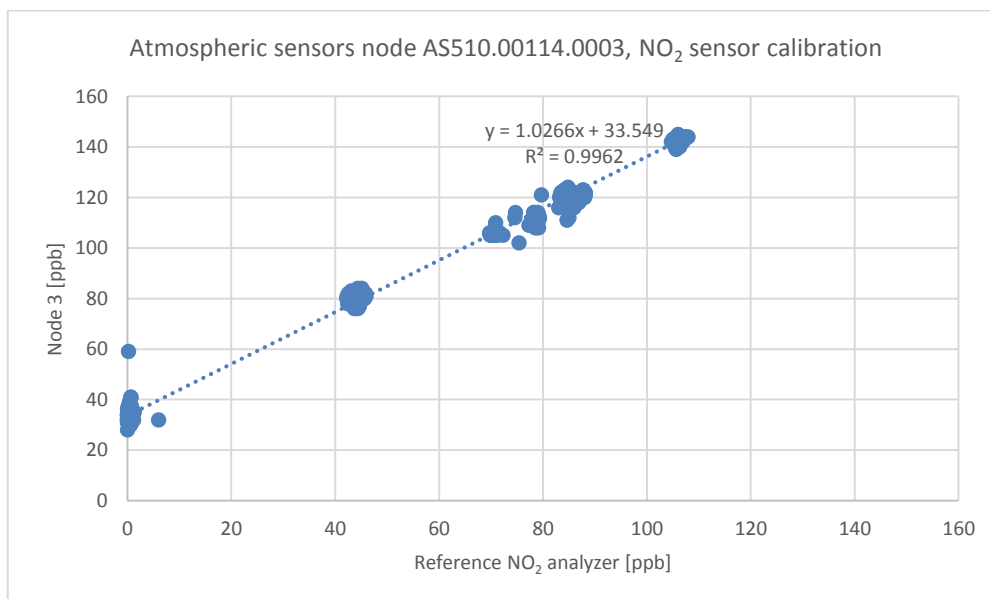

Fig. 21: NO₂ laboratory calibration of Atmospheric node

Good correlation between tested sensor and reference analyzer. The sensor did not react to high O₃ concentrations.

1.3.6.1.4 CO sensor

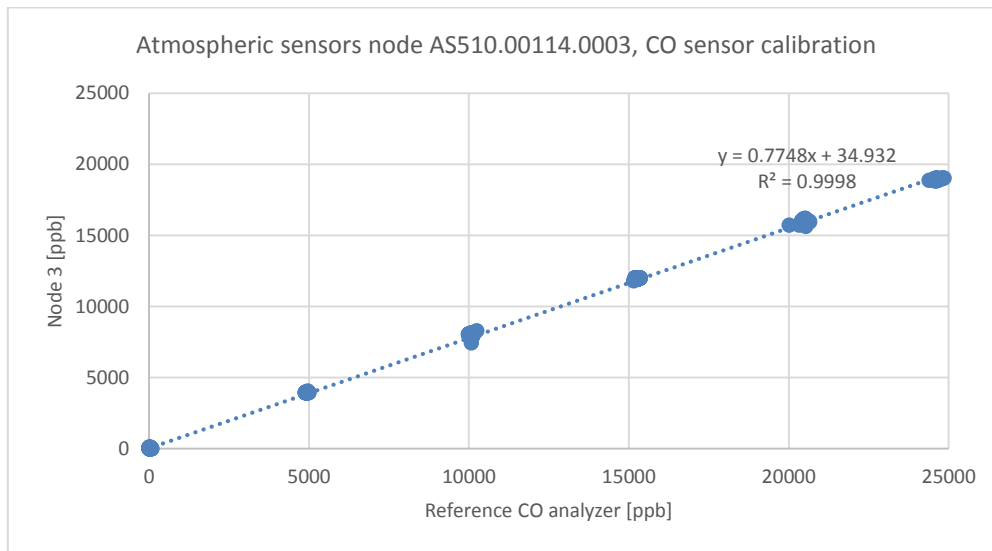

Fig. 22: CO laboratory calibration of Atmospheric node

Very good correlation between tested sensor and reference analyzer. No cross-sensitivity issue with other involved test gases.

1.3.7 Airbase CanarIT

CanarIT units were produced with two different configurations. The tested unit, 634, was intended for indoor measurement, with only two gas sensing devices: NO₂ and CO₂ sensors. The other type did not go through laboratory test but it went through extensive field tests done by Technion.

1.3.7.1.1 NO₂ sensor

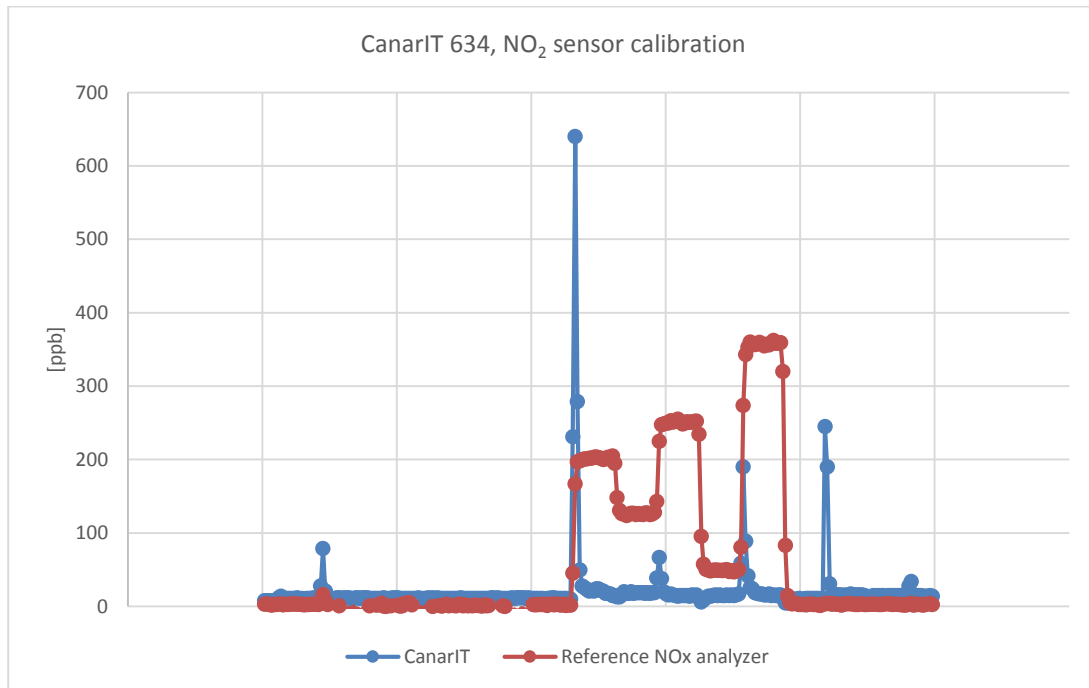

Fig. 23: NO₂ laboratory calibration of Airbase CanarIT unit

The obtained data series showed very low correlation between the two data sets.

1.3.8 Dunavnet node

Dunavnet sent one unit (device 4) to NILU at the beginning of 2014. The unit housing was not adequate for outdoor measurements and not optimal for laboratory tests either (no protection of electronics). A major issue with the unit concerned measurement intervals. Timestamps were drifting in a non-constant way which made correcting process challenging. Some of the datasets presented were not corrected and correlation evaluation were therefore not available. A new unit (device 12) was made available for test in March 2015. It showed no improvement regarding time stamp issue.

1.3.8.1.1 O₃ sensor

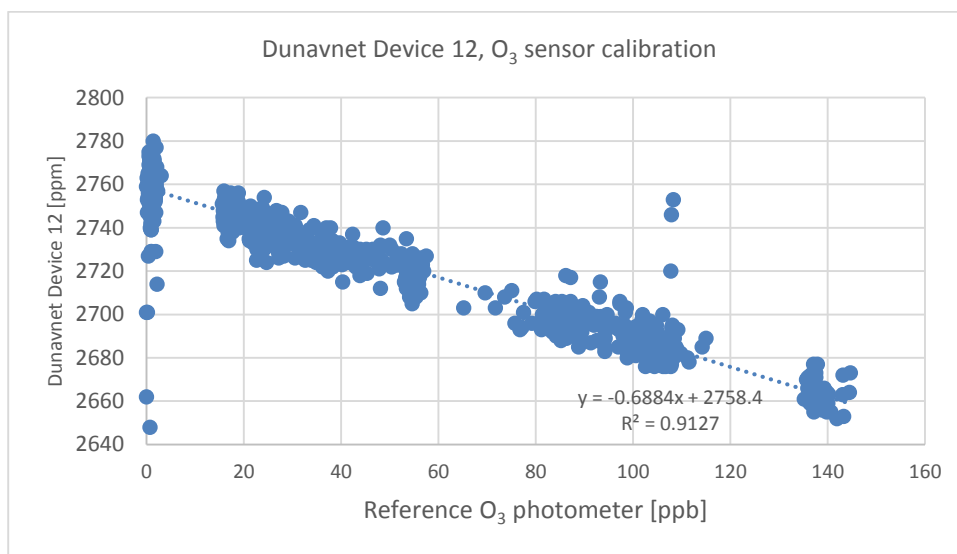

Fig. 24: O₃ laboratory calibration of Dunavnet unit

O₃ sensor required calibration. It showed cross-sensitivity with NO₂.

1.3.8.1.2 NO sensor calibration

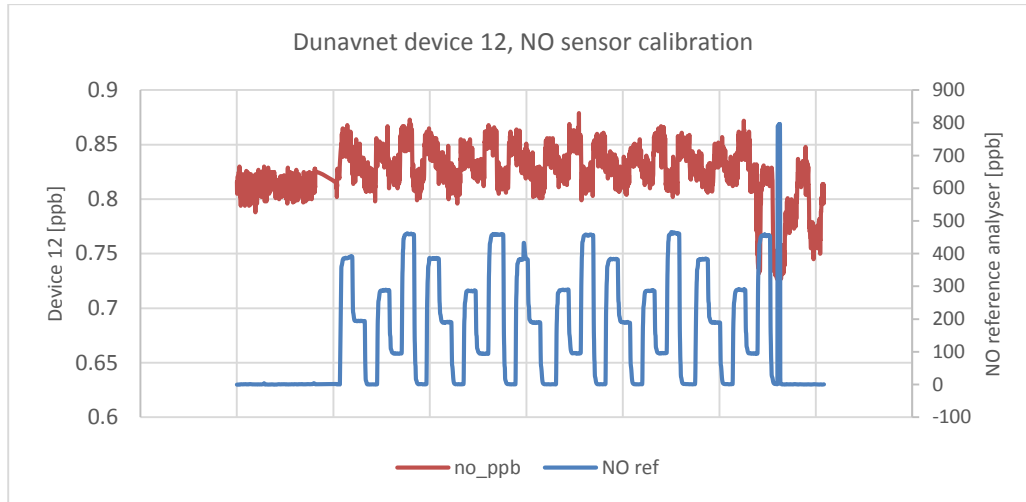

Fig. 25: NO laboratory calibration of Dunavnet unit

Correlation graph was not produced for this sensor.

1.3.8.1.3 NO₂ sensor

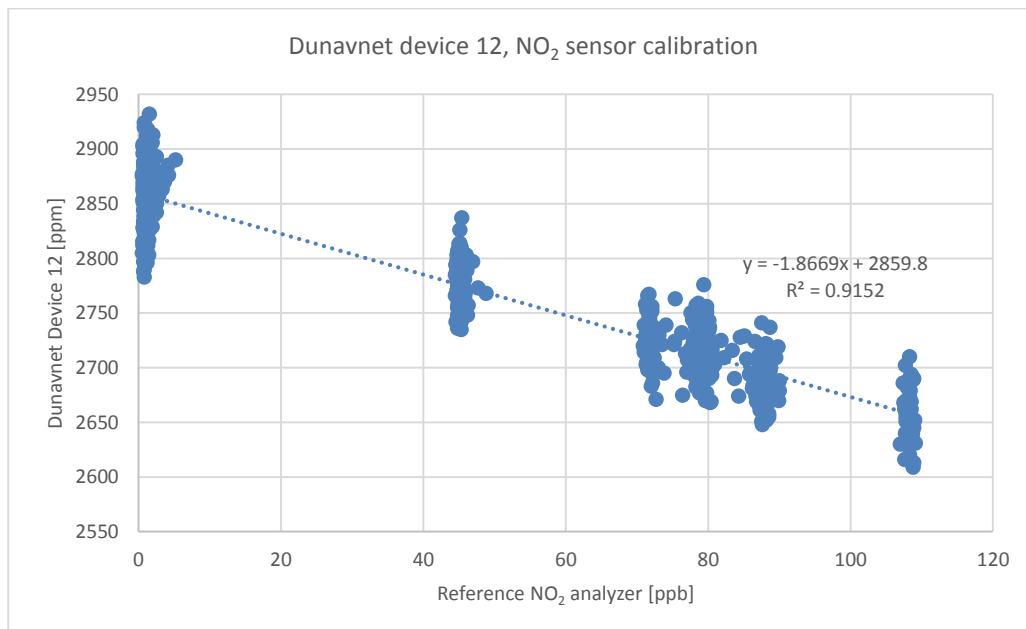

Fig. 26: NO₂ laboratory calibration of Dunavnet unit

NO₂ sensor required calibration. It showed high cross-sensitivity with O₃.

1.3.9 Discussion

Results from these basic laboratory tests indicate good quality data is achievable with current technology provided sensors are tested under steady temperature and relative humidity conditions, with simple air matrix.

However, it must be stressed that there was no focus on metrological issues such as long-term drift or hysteresis. Temperature and humidity variations are known to be strong influencing factors were not tested either.

All sensors tested on platforms chosen for final deployment showed excellent correlation with reference instruments, with most factors (see table 11 below) very close to 1.0. Sensor sensitivities (gradients from table 11) varied between 0.7 and 1.22.

Only one major cross-sensitivity issue has been identified through tests with available test gases. It concerns cross-sensitivity between NO_2 and O_3 sensors. The latest NO_2 sensors delivered by Alphasense addressed this issue by developing advanced filtering solutions which seem to offer effective rejection of O_3 . No modification was done on the O_3 sensors, meaning that the latter shows similar sensitivity to O_3 and NO_2 . Accurate O_3 measurements therefore requires algorithms involving outputs from both O_3 and NO_2 sensors (differential mode).

Tests done on latest versions of all three chosen platforms showed that only Geotech implemented such algorithms. The laboratory tests done on unit 688150 gave quite successful results. Ateknea and Atmospheric Sensor platforms apparently displayed raw outputs from these sensors. O_3 sensors from these platforms showed strong cross-sensitivity with NO_2 . However, this does not represent a major issue given the generated data can be post-processed.

Although the number of tested platforms was limited, the results appeared very promising.

Table 11. Summary of all platforms, including linear fit when compared to reference measurements. Note the linear fit is of the form:

$$[\text{Parameter}]_{\text{platform}} = ([\text{Parameter}]_{\text{reference}} * \text{gradient}) + \text{intercept}$$

Platform	Data Average Time (seconds)	Species/parameter	Coefficient of determination (r ²)	Gradient	Intercept [ppb]	Observed cross-sensitivity between gas species)
Geotech	900	CO	0.99	0.86	0.07	NO ₂ :N,O ₃ :N,NO:N
		NO	0.99	0.97	-1.13	NO ₂ :N,O ₃ :N,CO:N
		NO ₂	0.99	1.22	-1.02	O ₃ :N,NO:N,CO:N
		O ₃	0.99	1.16	-1.27	NO ₂ :L,CO:N,NO:N
Ateknea	60	NO ₂	0.99	0.86	23.9	NO N, O ₃ :N
		NO	0.99	0.71	-21.5	NO ₂ :N, O ₃ :N
		O ₃	0.96	0.70	-7.7	NO: N, NO ₂ :H
Atmospheric sensors	300	CO	0.99	0.77	34.93	NO:N,O ₃ :N,NO ₂ :N
		NO	0.99	0.82	8.38	CO:N,O ₃ :N,NO ₂ :N
		NO ₂	0.99	1.03	33.55	NO:N,CO:N,O ₃ :H
		O ₃	0.97	1.07	47.25	NO:N,CO:N,NO ₂ :N
Airbase	300	NO ₂	n.a.	n.a	n.a	n.a
Dunavnet	n.a	NO ₂	0.92	1.87	2859.8	
		O ₃	0.91	-0.69	2758.4	
		NO	n.a	n.a	n.a	

Table 12: Repeatability of measurements

Platform	Data Average Time [seconds]	Species/parameter	Mean measured value \pm std dev. with 0-air [ppb]	Mean reference value \pm std dev with 0-air [ppb]	Mean measured value \pm std. dev.at 100 pbb span (*) [ppb]	Mean reference value \pm std. dev.at 100ppb span [ppb]
Geotech AQMesh	900	CO	16.3 \pm 6	-21.9 \pm 9.7	1292 \pm 21.5	1385 \pm 16.2
		NO	n.a	0.4 \pm 0.4	88.5 \pm 1.5	94.1 \pm 0.9
		NO ₂	n.a	0.7 \pm 0.3	126.4 \pm 3.5	103.9 \pm 0.7
		O ₃	n.a	0.8 \pm 0.2	123.4 \pm 2.3	108.5 \pm 1.5
Ateknea LEO	10	NO	-15.3 \pm 10.8	0.4 \pm 0.3	49.0 \pm 8.7	94.3 \pm 0.6
		NO ₂	24.7 \pm 3.1	0.3 \pm 0.2	117.9 \pm 3.3	107.7 \pm 0.4
		O ₃	-6.8 \pm 4.1	0.5 \pm 0.5	57.5 \pm 3.4	86.1 \pm 0.6
Atmospheric sensors	300	CO	n.a	32.9 \pm 11.6	3940.5 \pm 20.0	4930.0 \pm 26.8
		NO	13.8 \pm 4.8	0.4 \pm 0.7	93.3 \pm 5.0	94.3 \pm 1.1
		NO ₂	33.7 \pm 5.6	0.3 \pm 0.2	142.9 \pm 1.2	106.3 \pm 0.8
		O ₃	41.5 \pm 17.1	0.6 \pm 0.2	136.8 \pm 4.1	84.9 \pm 1.2

(*): except for CO where 1300ppb was used as span value with AQMesh and 5000ppb with Atmospheric Sensor node

2 FIELD TRIALS OF PLATFORMS

Trial field deployments of some of the platforms have been conducted in some of the cities including Oslo, Edinburgh, Haifa and Barcelona. Other cities are Ljubljana, Ostrava and Vienna. In this section we present some of the results from these cities as a way of showing latest platform results and enhancements. While detailed results from Oslo are presented in this section, field trials from the other cities are reported in the Annex of this report. A summary description of these results will be provided in the final deliverables from the project.

2.1 Oslo study

The Oslo Empowerment Initiative used 24 static platforms from Geotech/AQMesh and 10 portable units from Ateknea for outdoor air quality monitoring. Atmospheric Sensor units were employed in indoor environments to monitor air pollutants and CO₂ concentrations.

The Geotech/AQMesh static platforms were received in April 2015 and since then have been co-located with an air quality monitoring station in Oslo.

The Ateknea portable units were received in September 2015. These units are not fully weather resistant, so they have not been co-located with an air quality monitoring station in Oslo. However, shorter comparisons for few hours from the platform against reference instruments have been conducted.

The Atmospheric Sensor units were co-located in Kirkeveien for a short period in May 2015. Additionally they were also co-located indoors in a meeting office at NILU with a Q-Track in order to evaluate the performance of the CO₂ sensor.

2.1.1 Description of study area

The Geotech/AQMesh were co-located at the station of Kirkeveien in Oslo. Kirkeveien station is classified as a traffic station. It is installed 5 meters from a busy street in the center of Oslo. The street roughly follow a SW-NE direction. It is mostly bordered by 4 to 5-floor buildings. There is one 5-floor building situated 11 m on the left-hand side of the station. The second closest building is located 14 m from the station, roughly 20 m from the street, on the right-hand side of the Kirkeveien station.



Figure.27 Picture of the measurement set-up of the 24 Geotech/AQMesh co-located together with the air quality station of Kirkeveien.



Figure.28 Picture of the measurement set-up of 4 Atmospheric Sensor platforms co-located together with the air quality station of Kirkeveien.

The Kirkeveien air quality monitoring station is instrumented with reference instruments monitoring both, gas species (O_3 , NO, NO_2 , CO, SO_2) and particulate matter (PM_{10} , $PM_{2.5}$). The table below shows the specifications of the reference instrumentation.

Table.13 Description and specifications of the reference instruments at Kirkeveien station.

Analyzer type	O_3	NO	NO_2	CO	$PM_{2.5}$	PM_{10}
Analyzer description	Teledyne API 400	Ecotech Serinus 40	Ecotech Serinus 40	Ecotech Serinus 30	Thermo TEOM 1405	Thermo TEOM 1405
max. meas. lev.	n.a	345 ppb	78 ppb	2759 ppb	180 $\mu\text{g}/\text{m}^3$	204 $\mu\text{g}/\text{m}^3$
aver. meas. lev.	n.a	24 ppb	17 ppb	318 ppb	10 $\mu\text{g}/\text{m}^3$	16 $\mu\text{g}/\text{m}^3$

The meteorological data was obtained from the meteorological station of Blindern, located in the vicinity of the Kirkeveien station. The station of Blindern is representative of the weather conditions in Oslo and it is maintained by the Norwegian Meteorological Institute.

The Figures show the pollutants concentrations registered at the Kirkeveien station during the period of co-location. Concentrations for NO_2 vary between 0 and 60 ppb. Concentrations of O_3 are lower, as expected in a station close to traffic, with concentrations ranging between 0 and 20 ppb. Values for CO are found mainly between 0 and 0.4 ppm, with peaks over 0.6 ppm. PM_{10} concentrations move in the range between 0 – 100 $\mu\text{g}/\text{m}^3$. Concentrations of $PM_{2.5}$ move in the range between 0-30 $\mu\text{g}/\text{m}^3$.

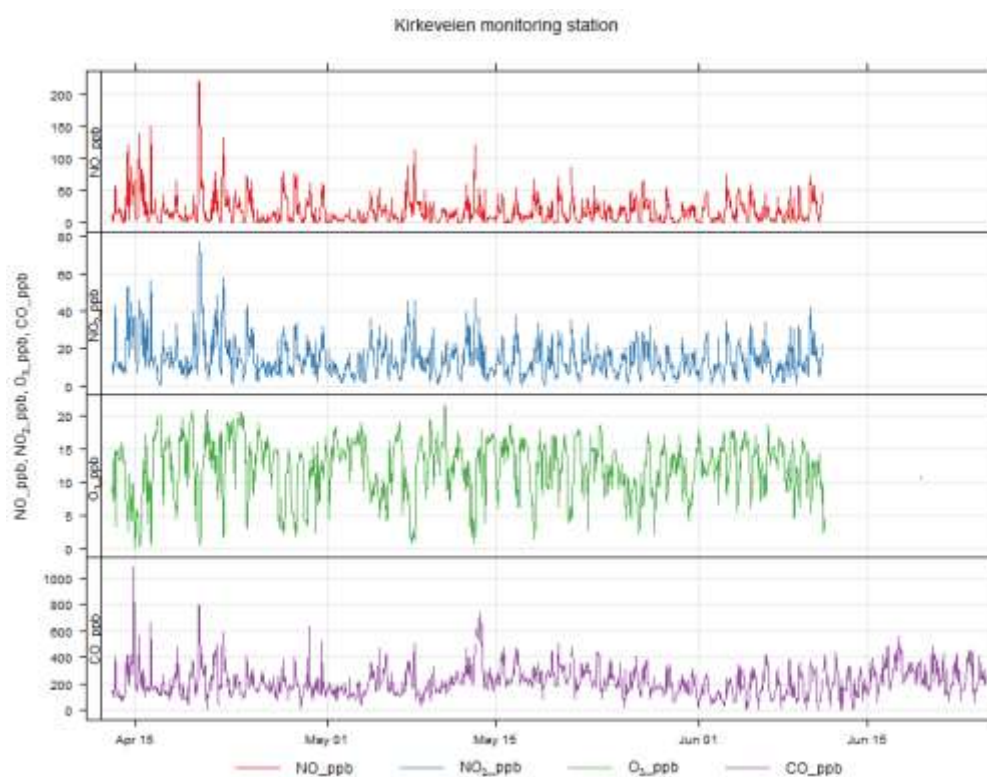

Figure.29 Gas concentrations measured with the reference equipment at Kirkeveien station during the co-location period (13 April to 24 June 2015)

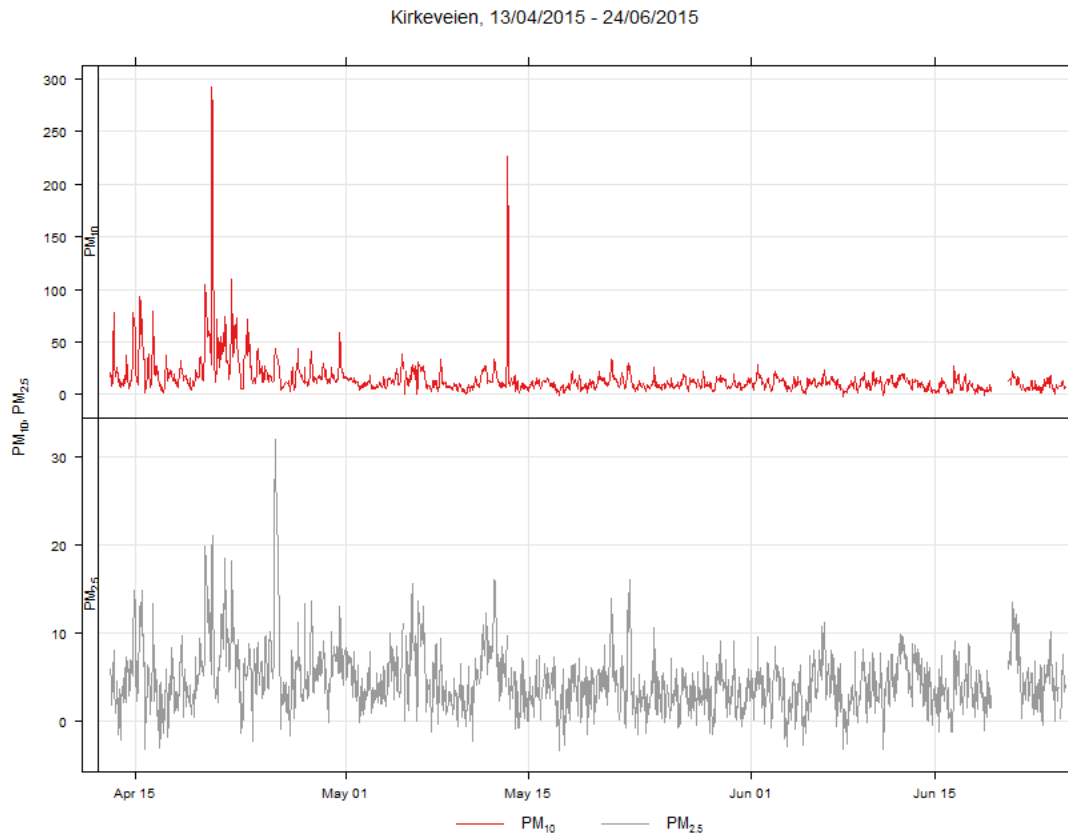

Figure.30 Particulate matter concentration (PM10 and PM2.5 in $\mu\text{g}/\text{m}^3$) measured with the reference equipment at Kirkeveien during the co-location period (13 April to 24 June 2015).

The meteorological conditions during the co-location period (see Figure below) show an average relative humidity of 63%, with maximum of 98% and a minimum of 19%. The temperature ranged between -0.7 C and 23.3 C , with an average temperature of 10 C .

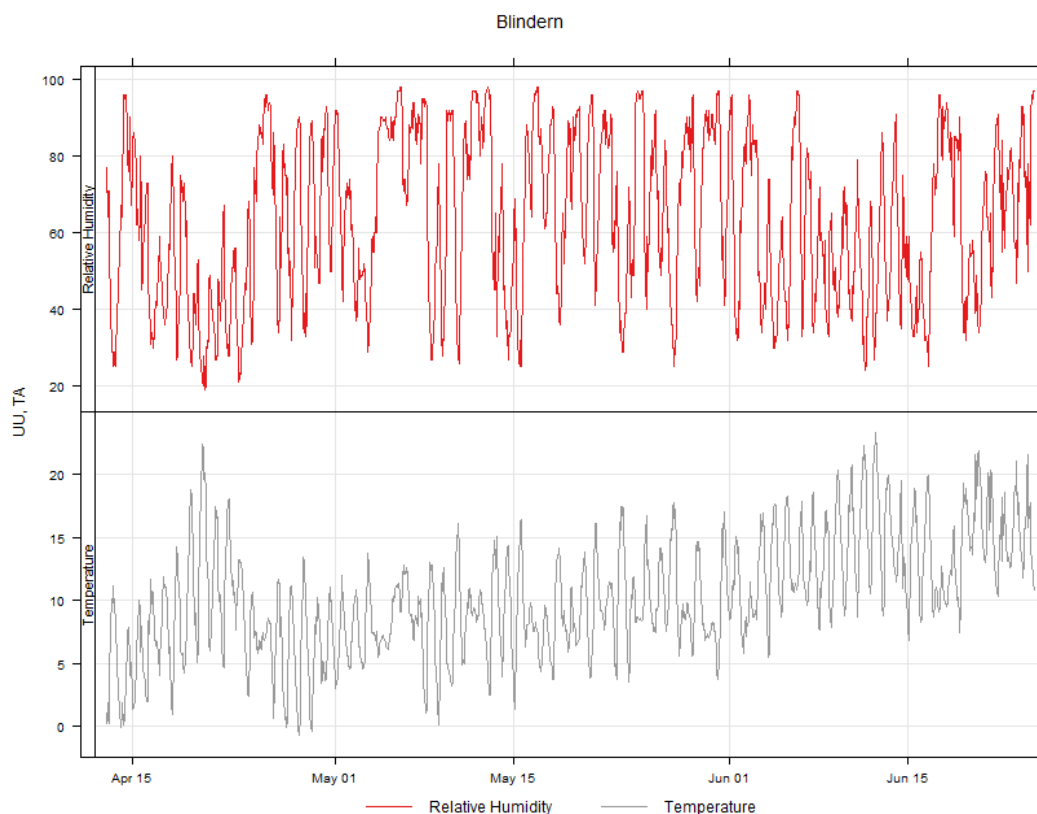

Figure 31: Relative Humidity and Temperature measured at Blindern station during the co-location period (13 April to 24 June 2015)

2.1.2 Methodology

For the analysis of the data hourly values from the Kirkeveien monitoring station were employed. The data from Kirkeveien has been through a quality control process performed at NILU. Only data that has passed the quality control process has been used.

In order to compare the data from the reference station with the data from the AQMesh units it is necessary to convert to the same units. The data from Kirkeveien was converted to ppb using the following equation:

$$\mu\text{g}/\text{m}^3 = (\text{ppb}) * (12.187) * (M) / (273.15 + T)$$

where M is the molecular weight of the gaseous pollutant and T is the temperature in °Celsius. An atmospheric pressure of 1 atmosphere is assumed.

Data from CO is measured in ppm by the reference instrument. In the original conversion to $\mu\text{g}/\text{m}^3$ there was no temperature correction (i.e., it was assumed a temperature of 20 °C and pressure of 1 atm). Same assumption has been employed to convert back to ppb.

Data from O₃ is directly measured in ppb, and no further conversion is required.

Particulate matter concentrations are expressed in $\mu\text{g}/\text{m}^3$ both in the Kirkeveien station and for the AQMesh pods. Then, no unit conversion is required.

The data from the AQMesh pods is expressed in an hourly basis for all the pods with the exception of the pod 688150 that has a temporal resolution of 15 min. The data from this pod was averaged to hourly resolution.

For the analysis, following the recommendations of the manufacturer, when the AQMesh concentrations are below -20ppb they are not considered for the analysis. When the sensor indicates concentrations below -20 ppb it is because it is clearly below the limit of detection. When this happens, the electrical signal is too low and the sensor is not measuring correctly. Analysis were performed also without cleaning the values below -20ppb. The results without filtering those values show worse performance (results not shown).

2.1.3 Field Results: Geotech/AQMesh platform

Table 14 shows the correlations (r^2) and linear calibration parameters obtained in field for the 24 pods for each pollutant. To conduct the analysis, hourly values for the period between 13 April 2015 and 24 June 2015 have been used. The linear fit is of the form:

$$[\text{Parameter}]_{\text{platform}} = ([\text{Parameter}]_{\text{reference}} * \text{gradient}) + \text{intercept}$$

For CO, the static sensors Geotech/AQMesh show a gradient close to 1 and the offset is in average 150 ppb. The correlations (R^2) move in the range between 0.22 and 0.45. 18 out of the 24 pods show correlations below 0.4.

For NO, the correlations are good. They move in the range between 0.36 and 0.95 but only one pod has a correlation below 0.4. 20 out of the 24 pods have a correlation higher than 0.6, and 10 of them have a correlation higher than 0.8.

For NO₂, the correlations are poor, varying between 0.045 and 0.51. 23 out of the 24 pods have a correlation below 0.4, and 7 of them below 0.2.

For O₃, the correlations are low for most of the pods. Correlation coefficients are in the range between 0.019 and 0.69. Only 2 of the 24 pods show a correlation factor above 0.5. 18 out of 24 pods have a correlation below 0.4, and 9 of them below 0.2.

For PM₁₀, the correlations are in the range between 0.11 and 0.5. However, by removing the values with relative humidity higher than 70% the correlation increases.

For PM_{2.5}, the correlation is lower than for PM10, and removing the values when the relative humidity was higher does not show an improvement in the correlations. The 24 pods show a correlation below 0.3.

Table 14. Summary of linear fit metrics for the Geotech sensor nodes when compared to reference measurements.

	Species/parameter	Correlation (r2)	Gradient	Intercept
688150	CO	0.34	0.88	166
712150	CO	0.36	0.87	166
715150	CO	0.41	0.95	149
718150	CO	0.32	0.85	152
733150	CO	0.38	1	150
737150	CO	0.34	0.92	151
743150	CO	0.41	0.99	151
744150	CO	0.27	0.8	158
746150	CO	0.39	1	151
750150	CO	0.42	1	149
751150	CO	0.39	0.86	152
756150	CO	0.37	0.93	150
764150	CO	0.39	0.76	153
785150	CO	0.25	0.86	158
828150	CO	0.35	0.93	147
846150	CO	0.45	1.1	143
849150	CO	0.34	0.99	151
850150	CO	0.43	0.99	150
855150	CO	0.22	0.82	160
856150	CO	0.35	0.93	151
861150	CO	0.35	0.98	148
862150	CO	0.34	1	150
863150	CO	0.36	0.97	150
864150	CO	0.43	1.1	143

	Species/parameter	Correlation (r2)	Gradient	Intercept
688150	NO	0.92	0.93	-0.12
712150	NO	0.78	0.65	4
715150	NO	0.91	0.79	2.5
718150	NO	0.62	0.58	5
733150	NO	0.93	0.76	0.15
737150	NO	0.94	0.79	-0.82
743150	NO	0.95	0.67	-0.9
744150	NO	0.86	0.74	2.2
746150	NO	0.68	0.61	1.9
750150	NO	0.87	0.78	3
755150	NO	0.84	0.75	-0.099
756150	NO	0.94	0.78	0.27
764150	NO	0.95	0.86	-1.3
785150	NO	0.36	0.34	7.3
828150	NO	0.75	0.76	14
846150	NO	0.63	0.65	18
849150	NO	0.75	0.74	15
850150	NO	0.53	0.57	16

855150	NO	0.41	0.32	7.7
856150	NO	0.55	0.59	14
861150	NO	0.73	0.78	14
862150	NO	0.67	0.78	8.6
863150	NO	0.74	0.81	15
864150	NO	0.74	0.76	12

	Species/parameter	Correlation (r2)	Gradient	Intercept
688150	NO2	0.42	0.38	3.8
712150	NO2	0.31	0.47	18
715150	NO2	0.13	0.22	14
718150	NO2	0.24	0.32	13
733150	NO2	0.23	0.3	12
737150	NO2	0.23	0.21	6.7
743150	NO2	0.16	0.18	9.5
744150	NO2	0.35	0.22	-1.6
746150	NO2	0.21	0.23	10
750150	NO2	0.22	0.21	7.9
755150	NO2	0.29	0.25	6.3
756150	NO2	0.13	0.22	15
764150	NO2	0.045	0.19	18
785150	NO2	0.28	0.12	2.8
828150	NO2	0.062	0.22	19
846150	NO2	0.51	0.32	-4.3
849150	NO2	0.3	0.19	3.1
850150	NO2	0.38	0.27	1.7
855150	NO2	0.32	0.2	3.3
856150	NO2	0.37	0.25	4
861150	NO2	0.28	0.25	9.3
862150	NO2	0.28	6.1	0.37
863150	NO2	0.18	0.18	10
864150	NO2	0.091	0.2	16

	Species/parameter	Correlation (r2)	Gradient	Intercept
688150	O3	0.65	0.26	7.2
712150	O3	0.3	0.16	3
715150	O3	0.27	0.16	4.7
718150	O3	0.53	0.25	-0.58
733150	O3	0.15	0.15	13
737150	O3	0.57	0.22	6.7
743150	O3	0.5	0.26	11
744150	O3	0.048	0.1	14
746150	O3	0.6	0.21	3.9
750150	O3	0.61	0.22	8.2
755150	O3	0.49	0.22	8.1
756150	O3	0.23	0.16	10
764150	O3	0.0088	0.027	12
785150	O3	0.19	0.21	18

828150	O3	0.16	0.09	7.1
846150	O3	0.24	0.16	12
849150	O3	0.3	0.2	13
850150	O3	0.26	0.15	6.7
855150	O3	0.29	0.18	12
856150	O3	0.27	0.17	12
861150	O3	0.49	0.24	5.2
862150	O3	0.3	0.13	6
863150	O3	0.31	0.18	11
864150	O3	0.1	0.11	9

	Species/parameter	Correlation (r2)	Gradient	Intercept
688150	PM10	0.53	1.3	5.6
712150	PM10	0.41	0.84	7.8
715150	PM10	0.37	0.49	7.4
718150	PM10	0.13	0.29	10
733150	PM10	0.43	0.6	5.8
737150	PM10	0.24	0.41	8.7
743150	PM10	0.37	0.58	6.2
744150	PM10	0.33	1	6.8
746150	PM10	0.33	0.43	8.3
750150	PM10	0.39	0.49	7.5
755150	PM10	0.4	0.99	6.8
756150	PM10	0.36	0.54	6.7
764150	PM10	0.39	0.54	6.7
785150	PM10	0.39	1.1	5.8
828150	PM10	0.32	0.48	7.5
846150	PM10	0.38	0.45	8
849150	PM10	0.46	0.56	6.4
850150	PM10	0.42	0.49	7.4
855150	PM10	0.11	0.37	11
856150	PM10	0.39	0.51	7.3
861150	PM10	0.11	0.24	10
862150	PM10	0.38	1.1	6.6
863150	PM10	0.31	0.42	8.5
864150	PM10	0.46	0.6	5.8

	Species/parameter	Correlation (r2)	Gradient	Intercept
688150	PM2.5	0.4	0.51	3.3
712150	PM2.5	0.28	0.37	3.5
715150	PM2.5	0.27	0.26	3.2
718150	PM2.5	0.24	0.23	3.4
733150	PM2.5	0.32	0.29	3
737150	PM2.5	0.25	0.25	3.3
743150	PM2.5	0.31	0.3	3
744150	PM2.5	0.18	0.21	3.5
746150	PM2.5	0.26	0.26	3.2
750150	PM2.5	0.25	0.24	3.3
755150	PM2.5	0.24	0.29	3.5

756150	PM2.5	0.27	0.26	3.2
764150	PM2.5	0.27	0.27	3.1
785150	PM2.5	0.24	0.34	3.5
828150	PM2.5	0.27	0.27	3.1
846150	PM2.5	0.27	0.26	3.2
849150	PM2.5	0.32	0.3	3
850150	PM2.5	0.28	0.27	3.2
855150	PM2.5	0.23	0.35	3.4
856150	PM2.5	0.25	0.26	3.2
861150	PM2.5	0.23	0.24	3.3
862150	PM2.5	0.19	0.28	3.6
863150	PM2.5	0.22	0.22	3.4
864150	PM2.5	0.28	0.28	3.1

Figures 32 to 37 show the time series plots and correlation plots for three pods: 688150, 855150 and 864150. The pod 688150 was tested in the laboratory prior to their co-location, and the pod 864150 was tested in the laboratory after the co-location at Kirkeveien. The results in laboratory showed a good performance for both pods 688150 and 864150, except some cross-sensitivity issues with NO₂ on the O₃ sensor from pod 864150. However, the results in field are very different between them. While the pod 688150 shows a relatively good performance, the pod 864150 performs poorly. A possible explanation is this relatively high NO₂ cross-sensitivity displayed by its O₃ sensor.

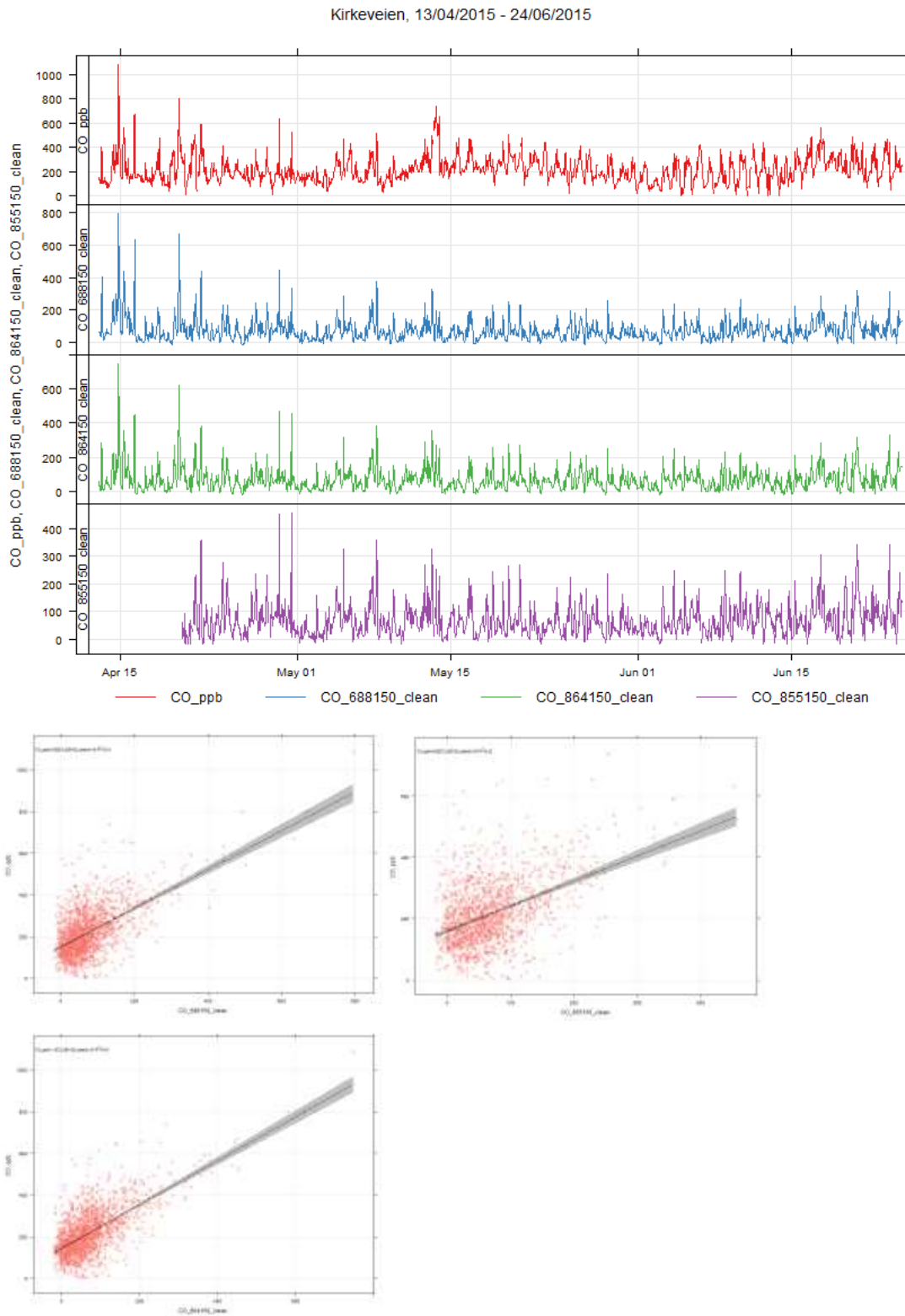

Figure.32 Time series and scatter plots for CO during the co-location at Kirkeveien station.

Kirkeveien, 13/04/2015 - 24/06/2015

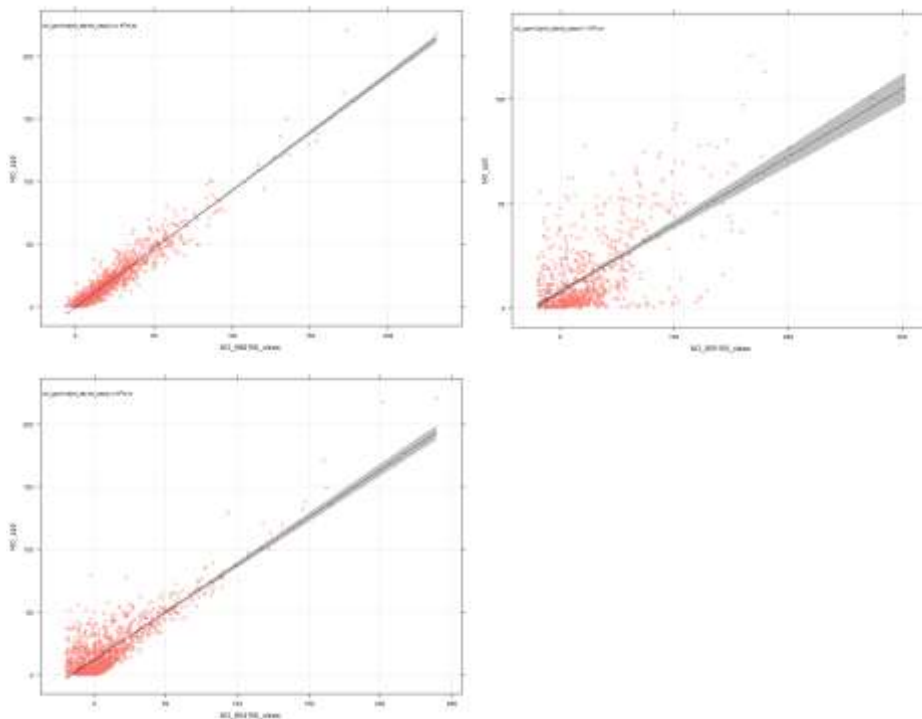

Figure.33 Time series and scatter plots for NO during the co-location at Kirkeveien station.

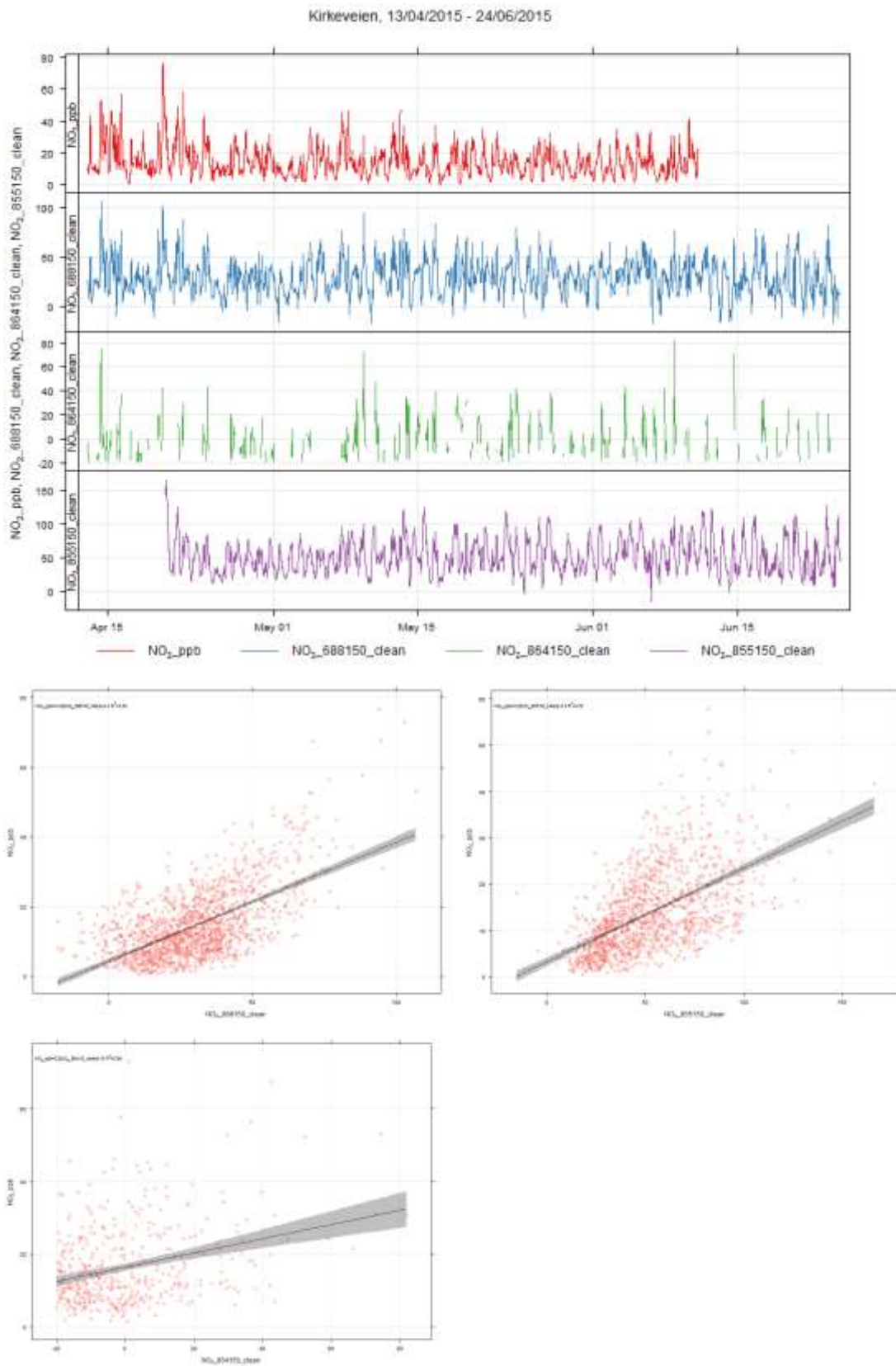

Figure.34 Time series and scatter plots for NO₂ during the co-location at Kirkeveien station.

Kirkeveien, 13/04/2015 - 24/06/2015

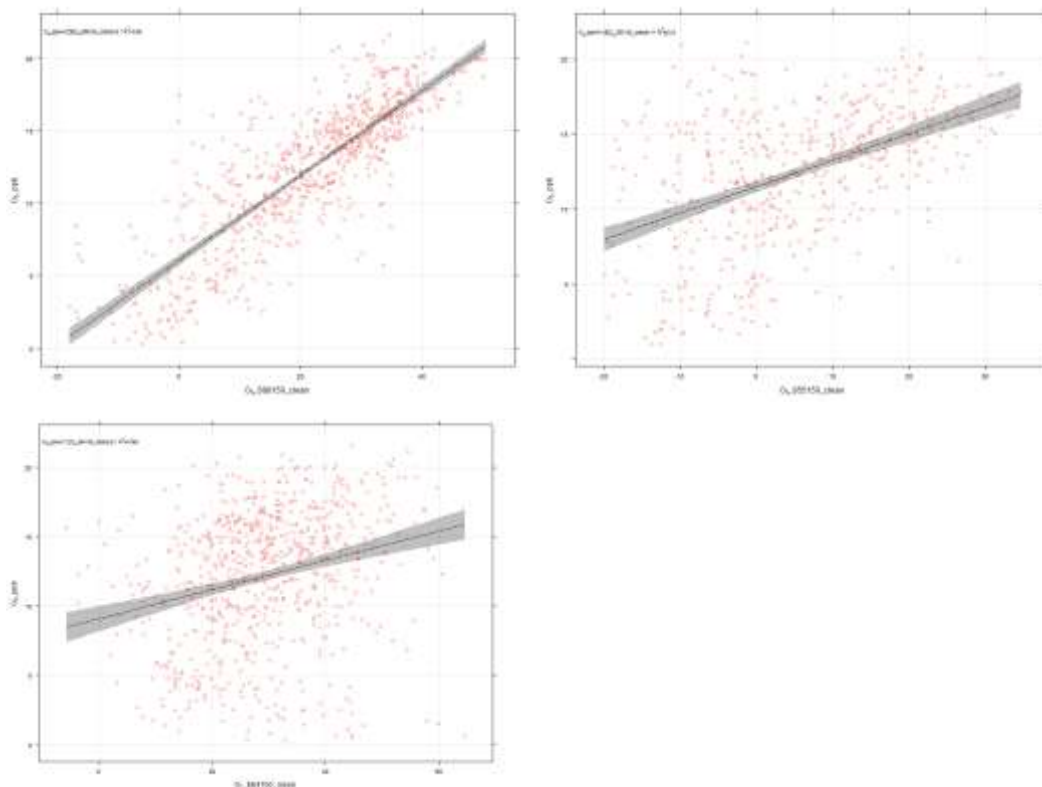
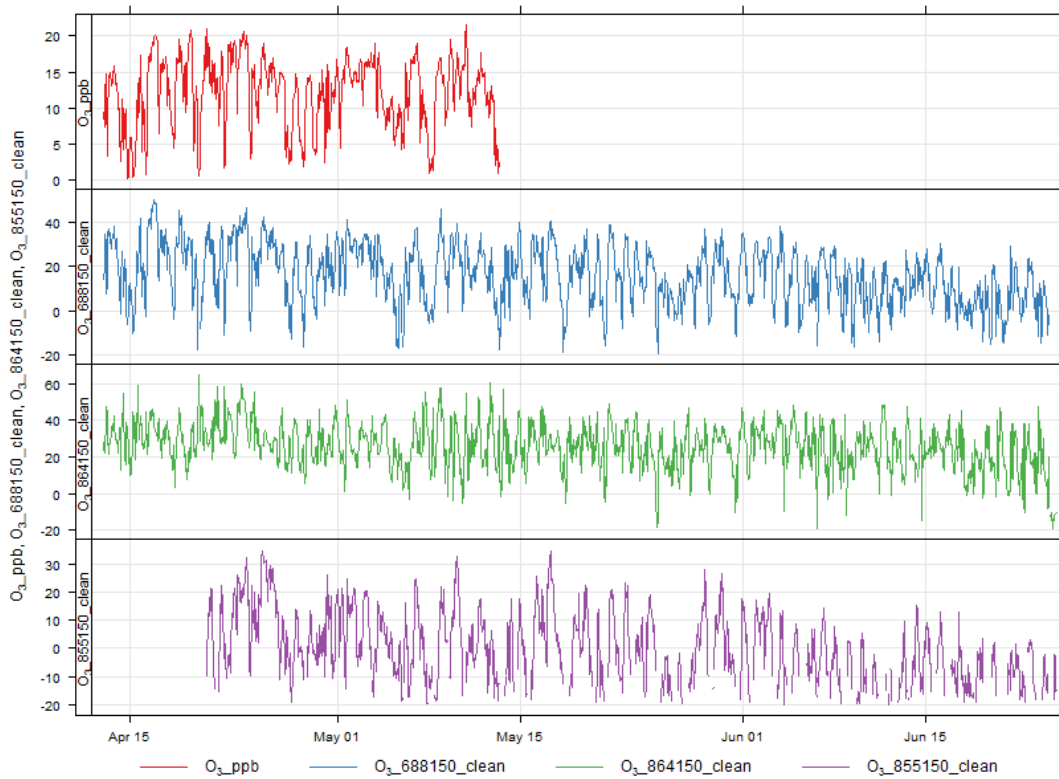

Figure.35 Time series and scatter plots for O₃ during the co-location at Kirkeveien station.

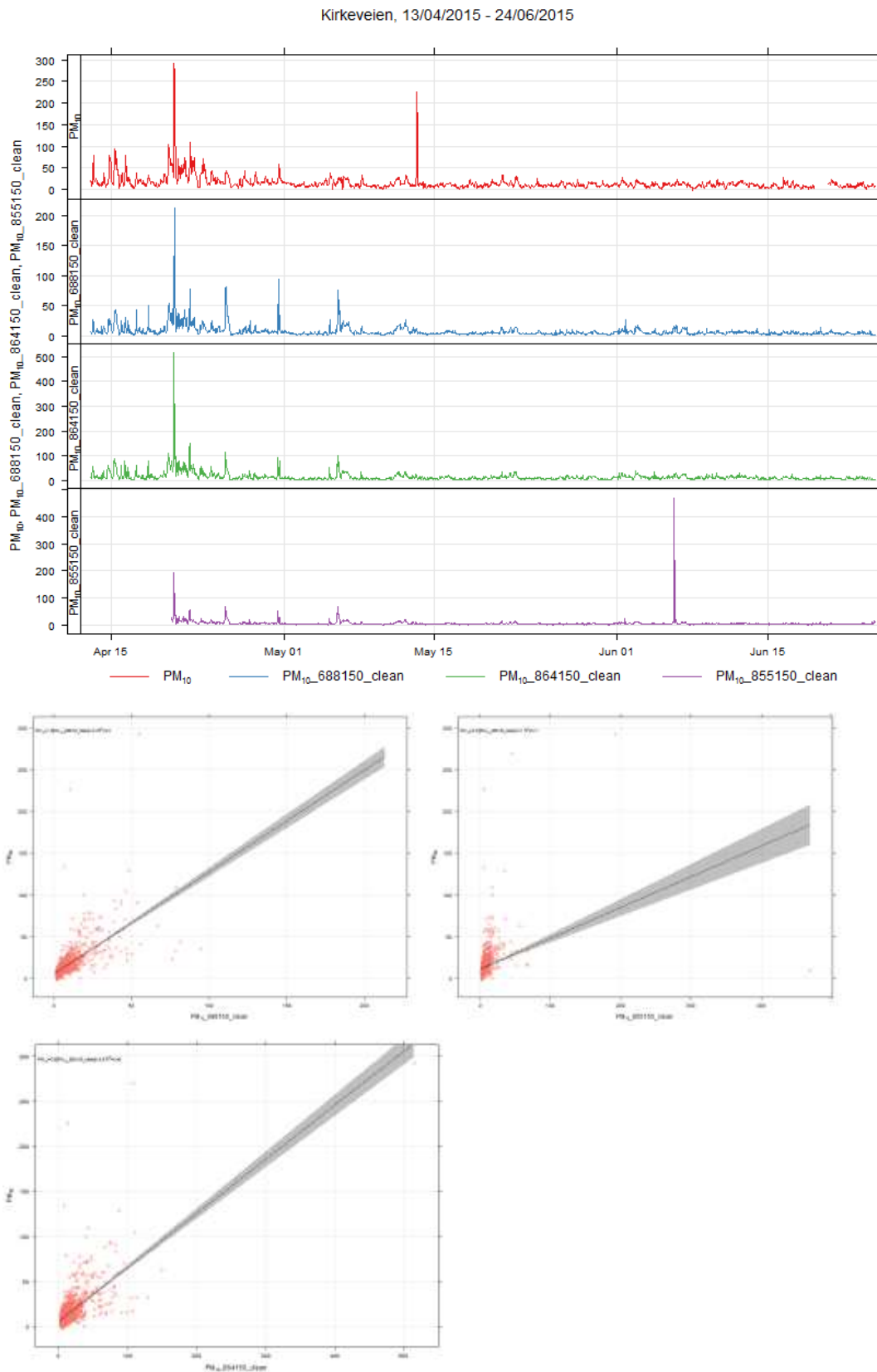

Figure.36 Time series and scatter plots for PM₁₀ during the co-location at Kirkeveien station.

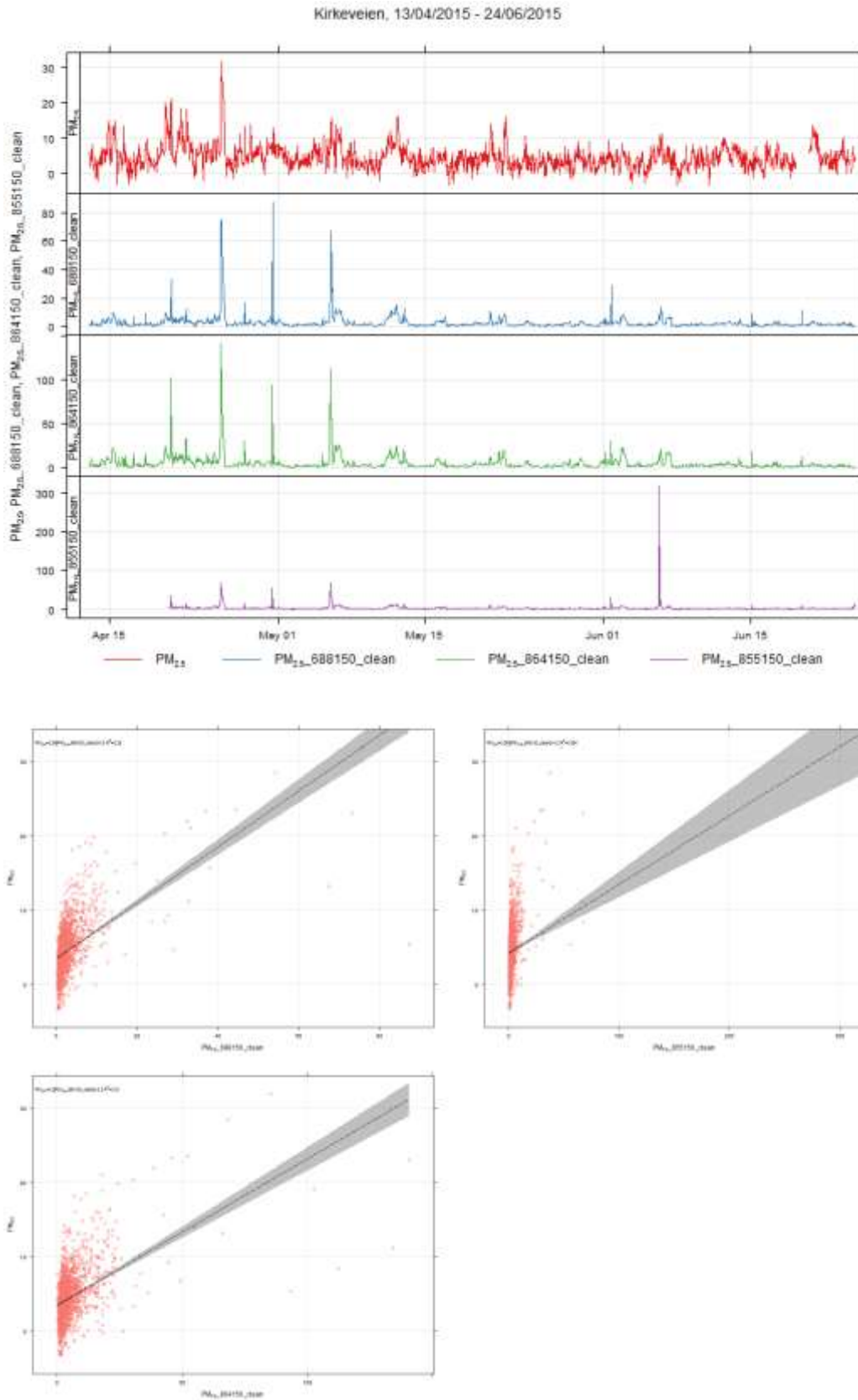

Figure.37 Time series and scatter plots for $PM_{2.5}$ during the co-location at Kirkeveien station.

2.1.4 Conclusions

Although laboratory tests of Geotech AQMesh showed an excellent performance of all gas sensors, deployment of a large number of identical platforms at the same AQM station gave mixed results. While NO sensors performed undeniably well, NO₂ sensors showed worst correlation with reference instrument. Whereas accuracy of measurements can theoretically be enhanced through co-location calibration, precision improvement is a much more challenging task. It is however required for many of the sensors involved in this field assessment in order to offer useful data. It is also worth noting a worrying lack of consistency between platform measurements.

ANNEX

A. Cambridge Field assessment

This part of the annex presents addition results from the platforms used for field assessment at UCAM.

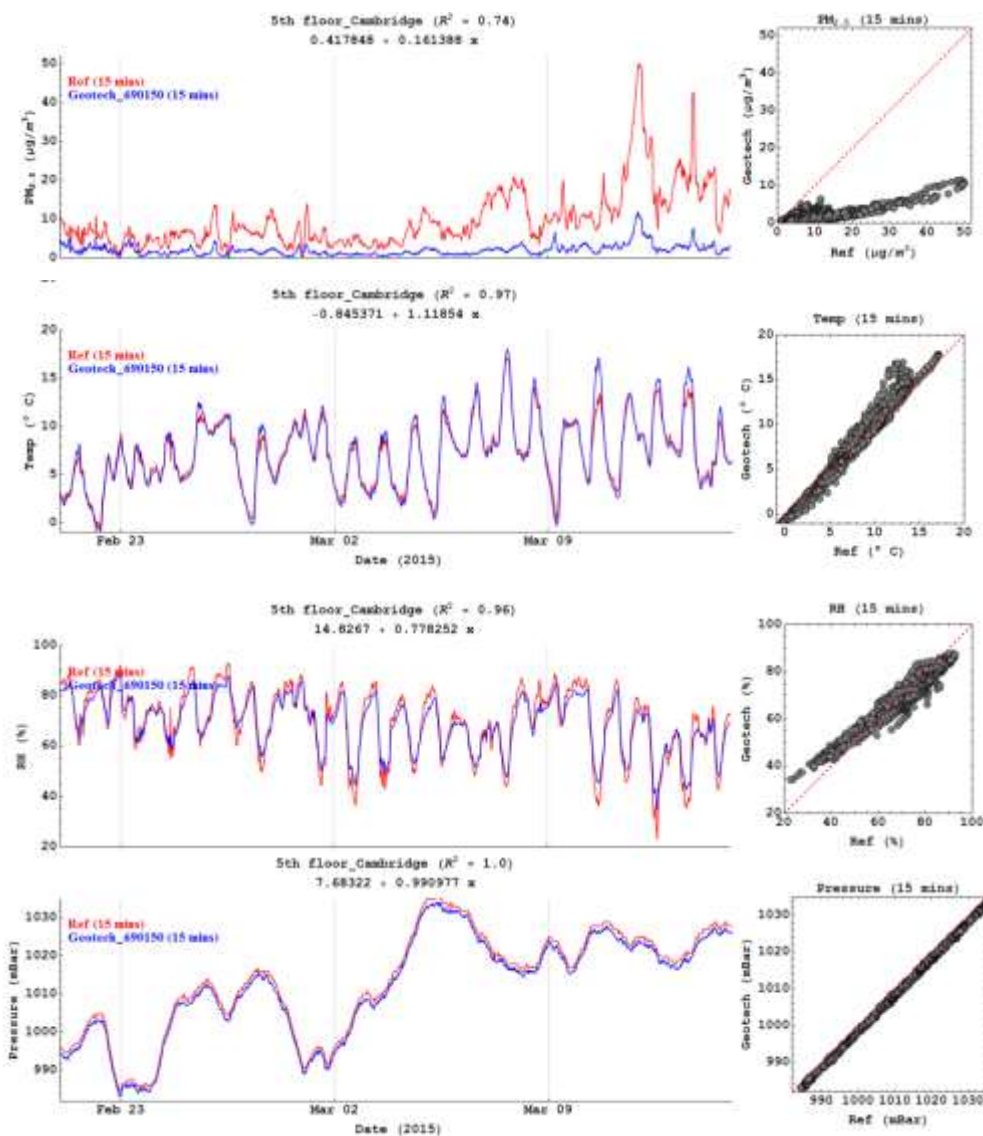

Figure A1. Time series and correlation plots of PM_{2.5} concentrations, temperature, RH and pressure from the reference instruments and a Geotech pod. Data covers 23 days (21 February to 15 March, 2015).

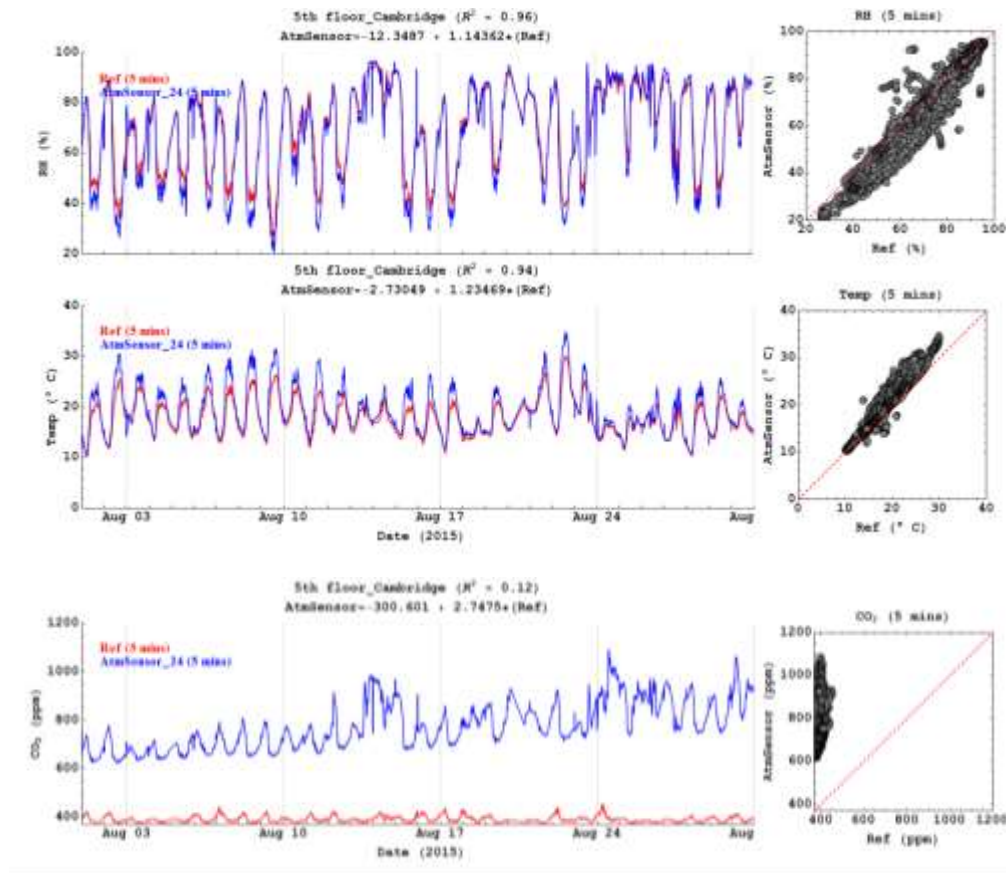

Figure A2. Time series and correlation plots of RH, ambient temperature and raw CO₂ mixing ratios from the reference instruments and one of the Atmospheric sensor nodes. Data covers 31 days (1 to 31 August, 2015). Data produced using UCAM algorithm.

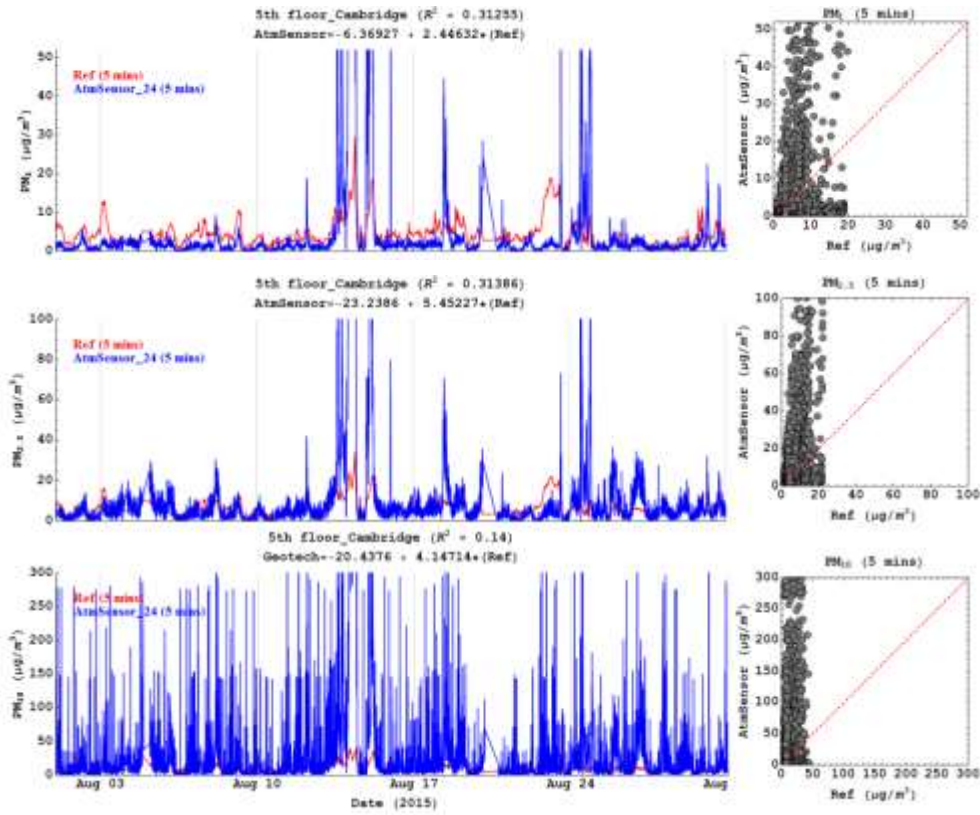

Figure A3. Equivalent plots to figure A2 for PM₁, PM_{2.5} and PM₁₀ concentrations

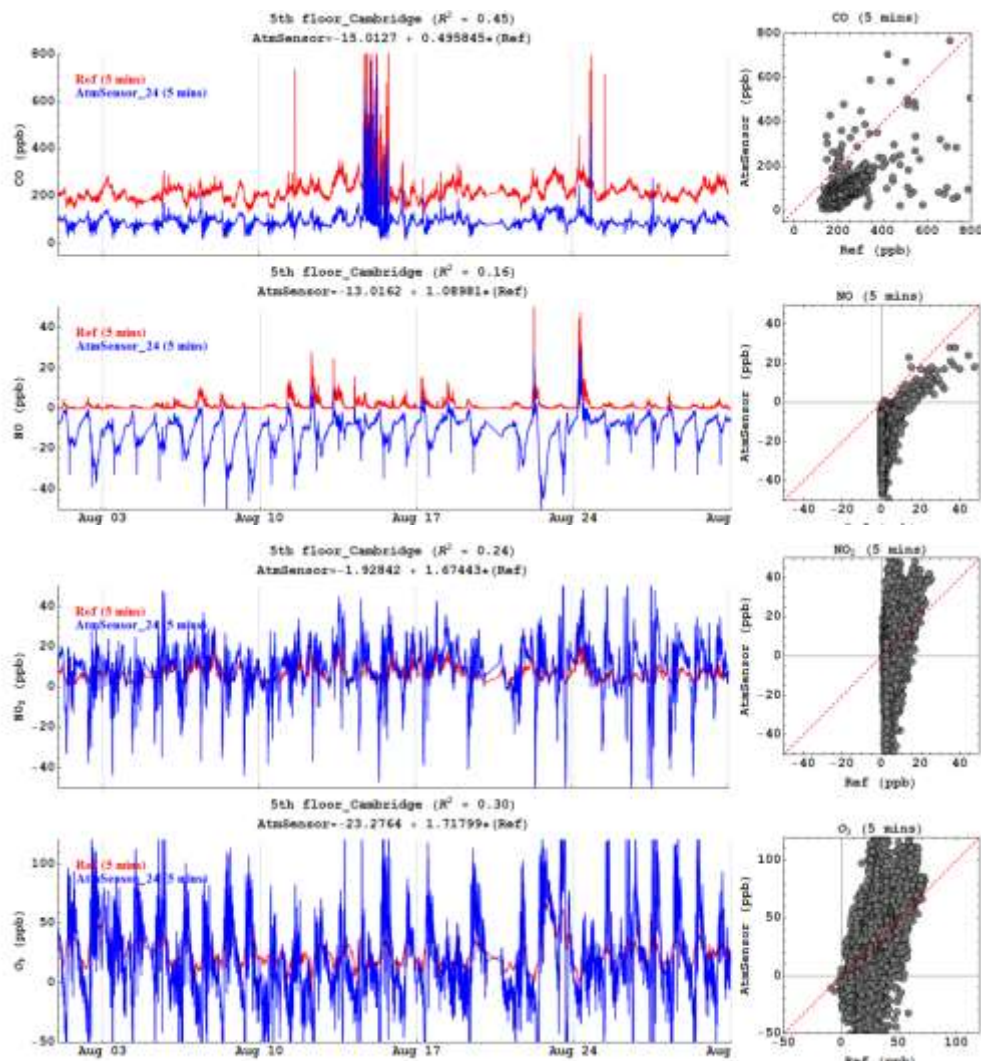
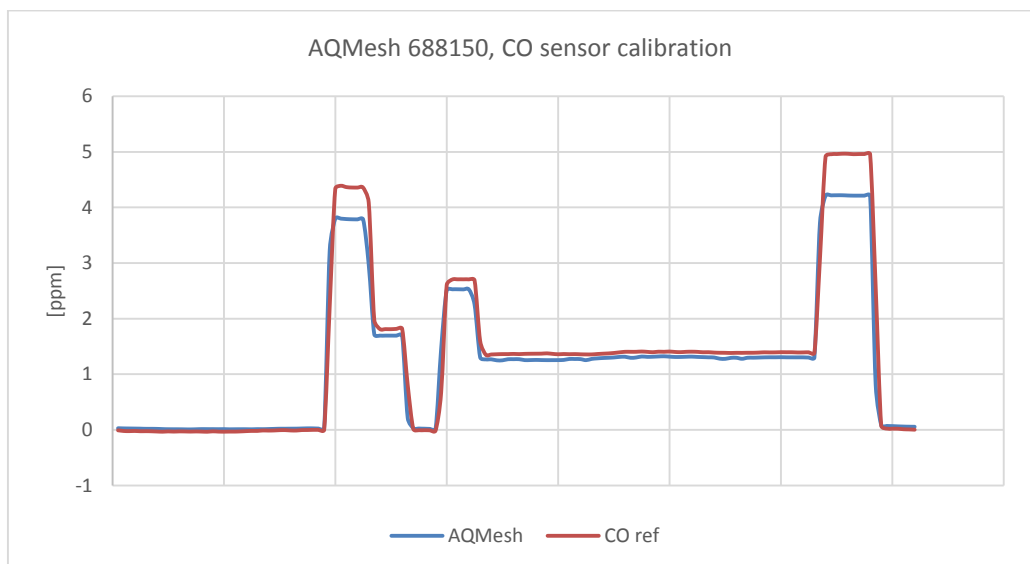
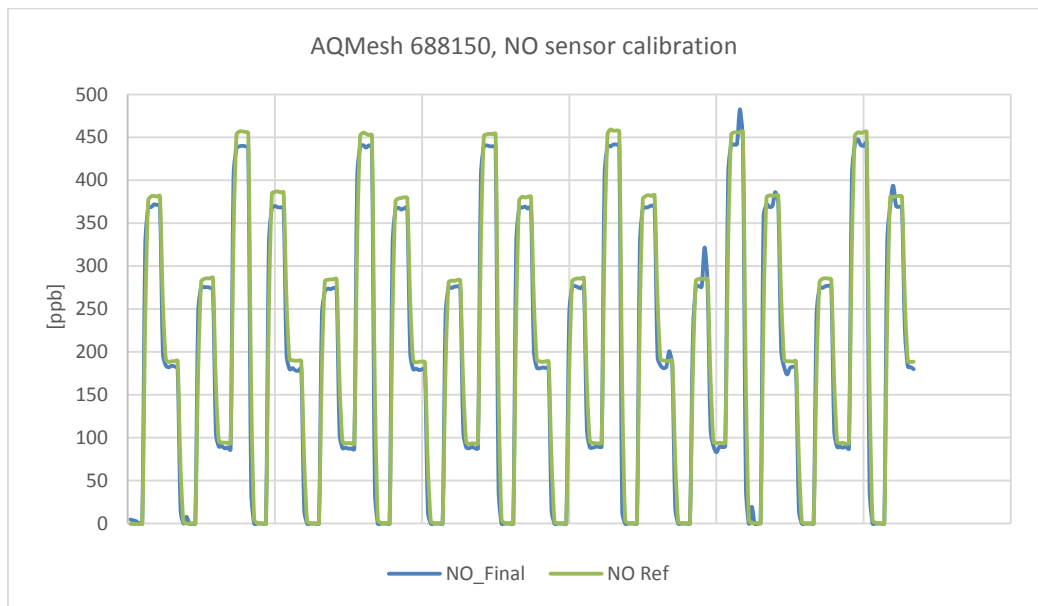

Figure A4. Time series and correlation plots of CO, NO, NO₂ and O₃ mixing ratios from the reference instruments and one of the Atmospheric sensor node. Data covers 31 days (1 to 31 August, 2015). Data produced using revised atmospheric sensor algorithm. Compare to UCAM algorithm analysis figure 8.

B. Laboratory tests: data series

The following part of the annex displays most of data series generated under laboratory tests. Some of them include measurement of several gas species and clearly display cross-sensitivity issues.

Geotech AQMesh



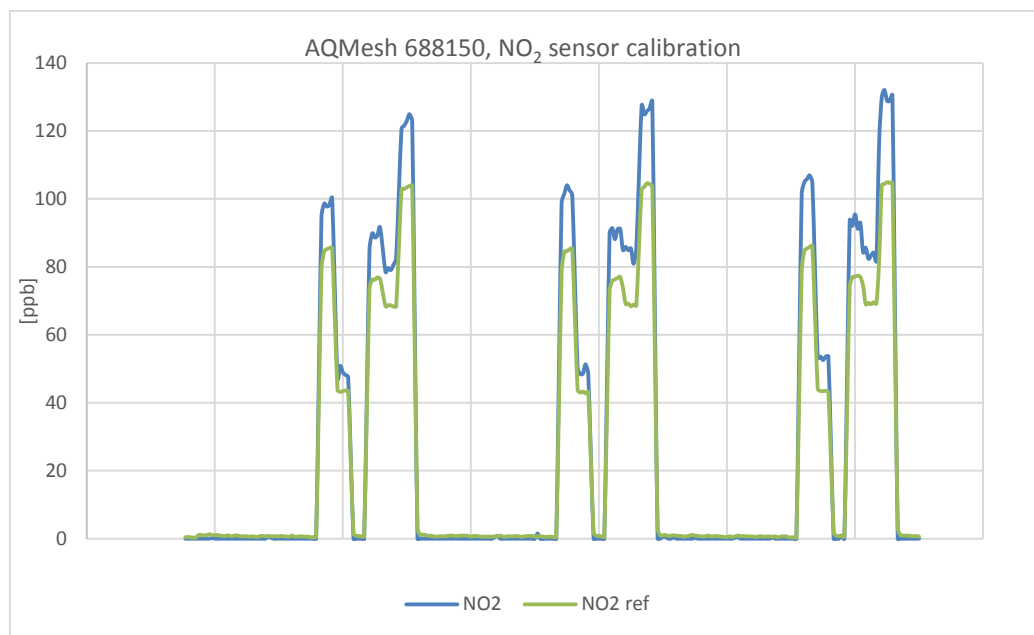
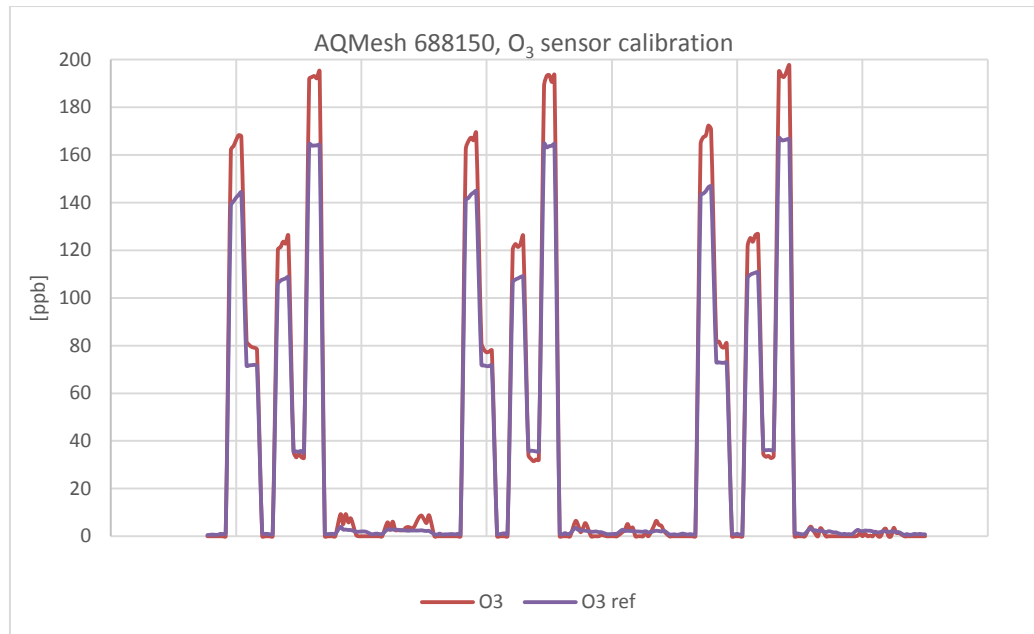

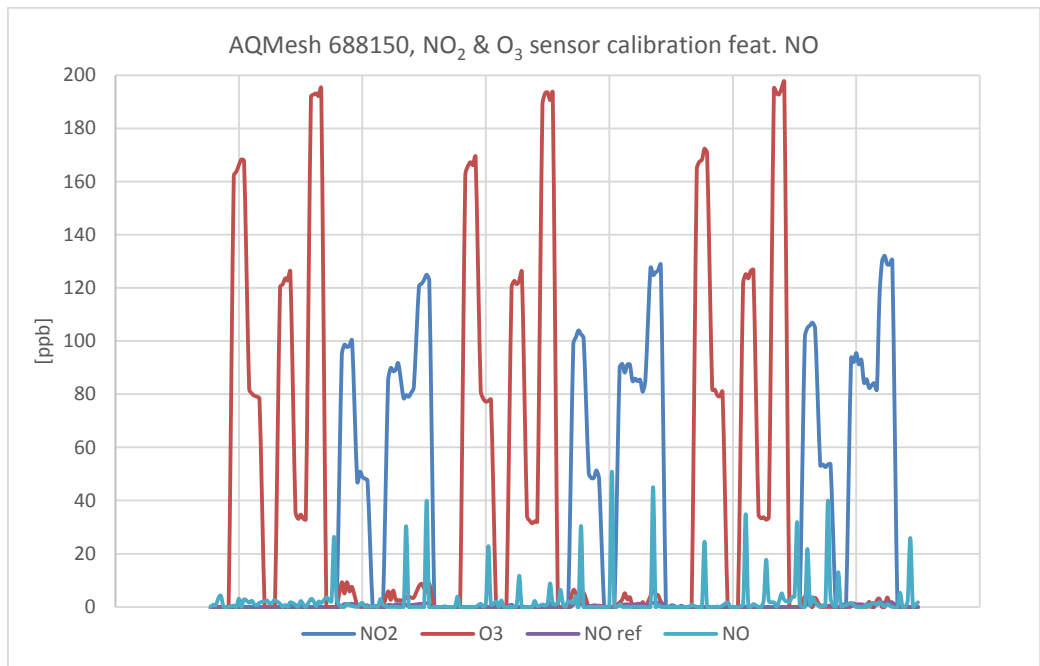
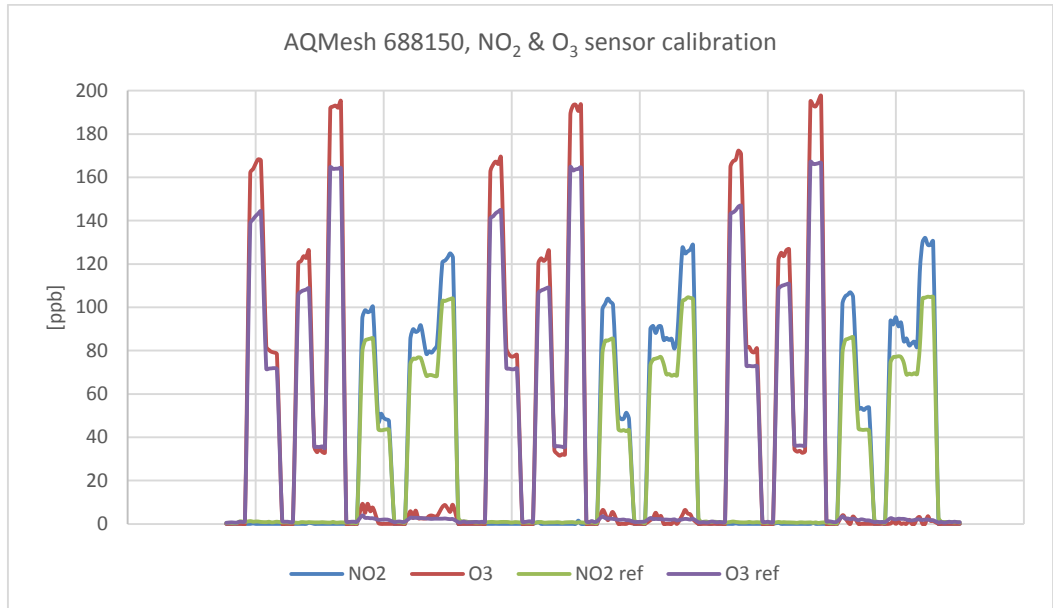

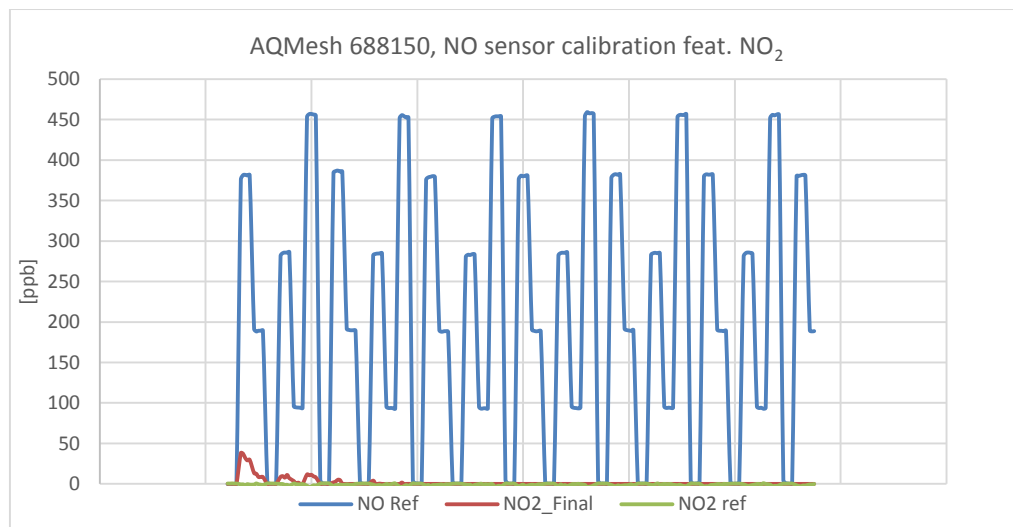
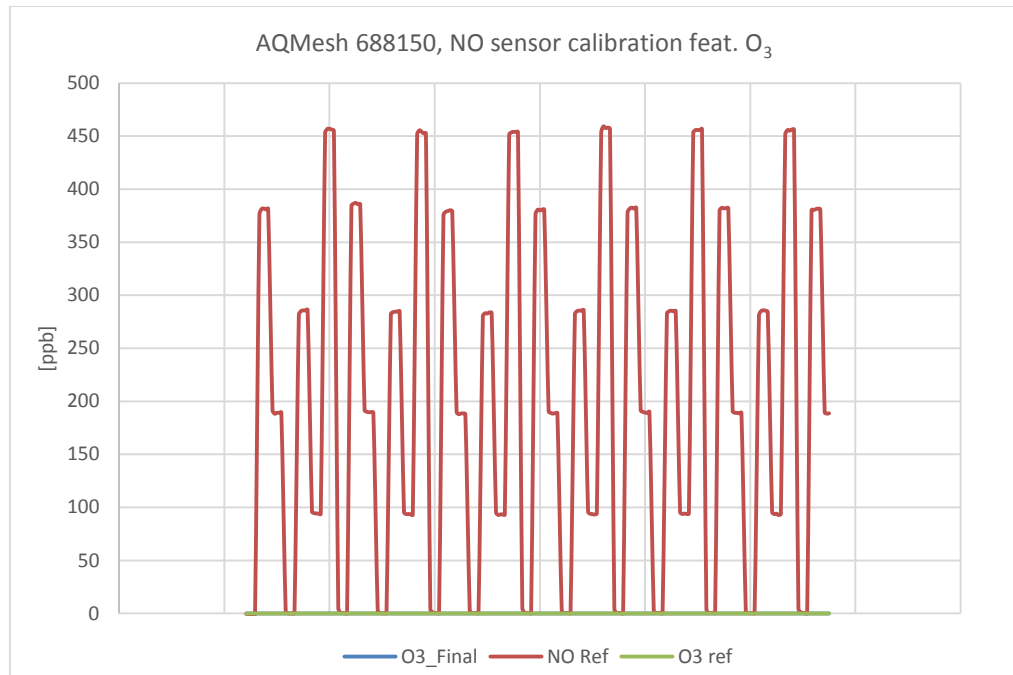

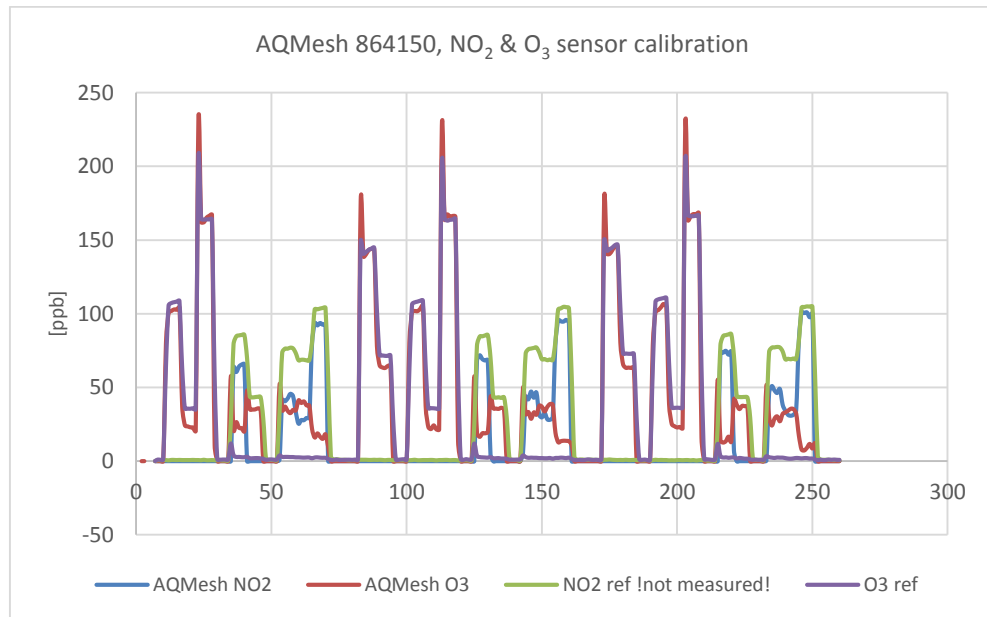

Atmospheric sensors

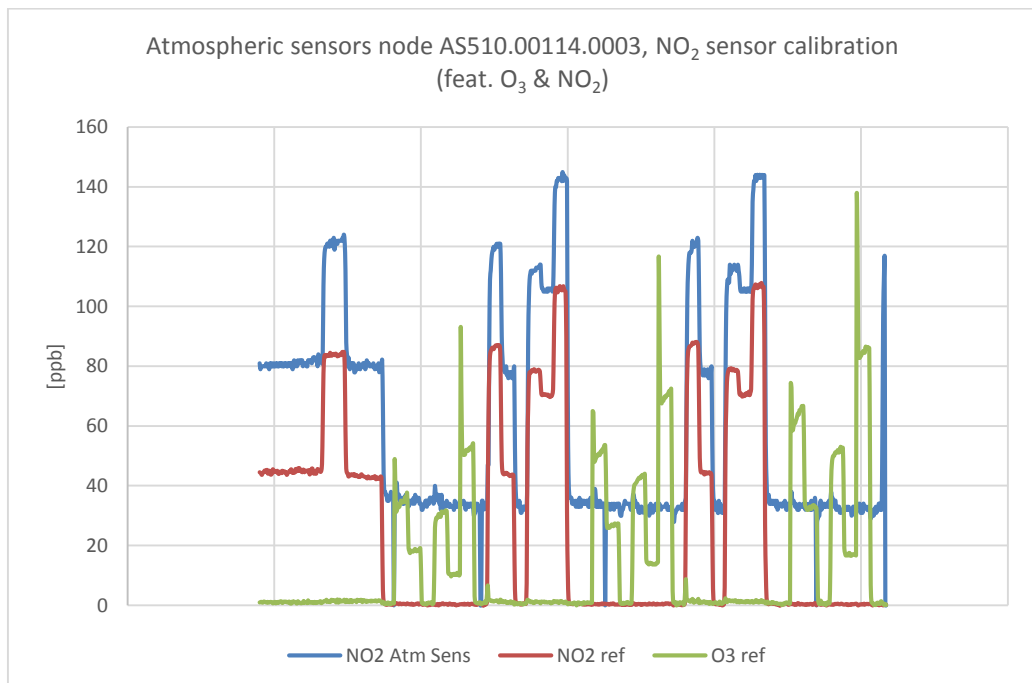
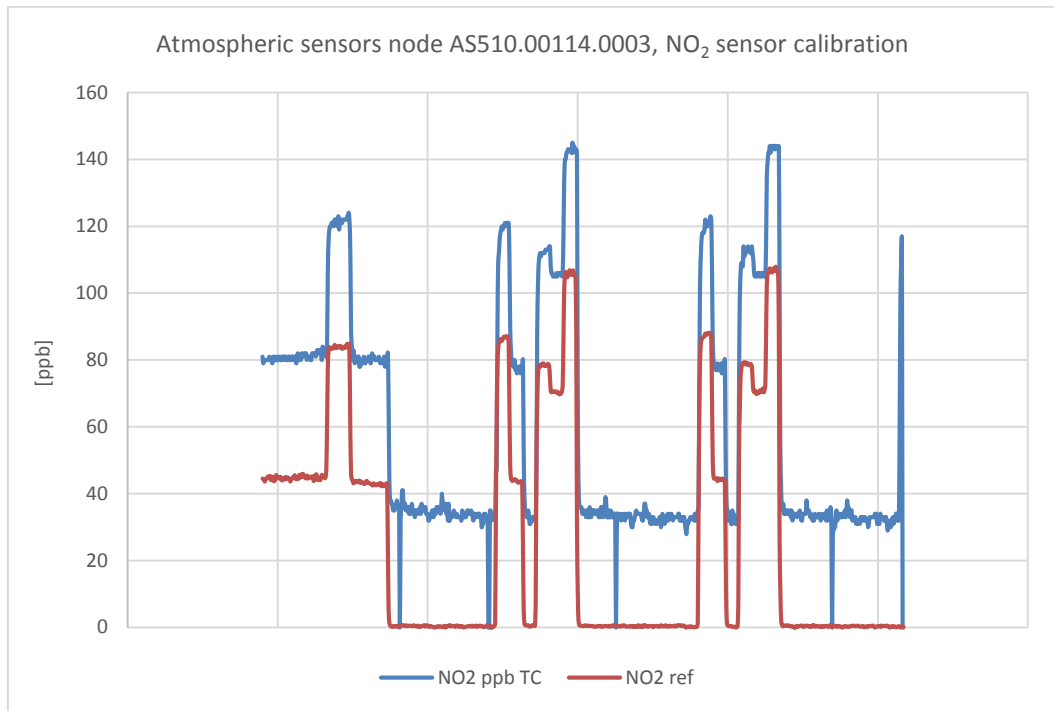

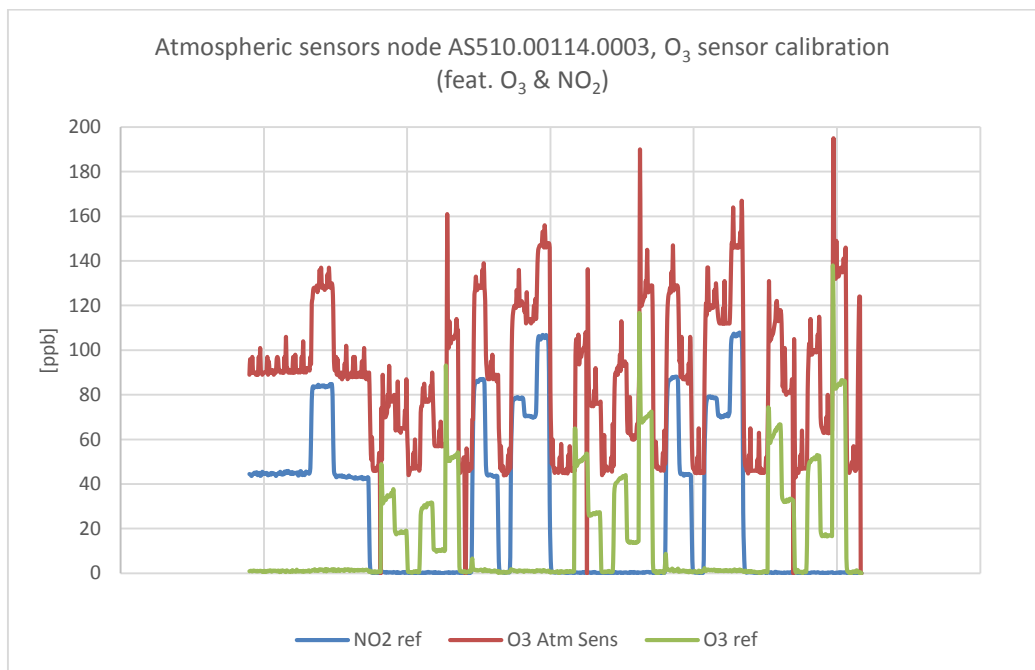
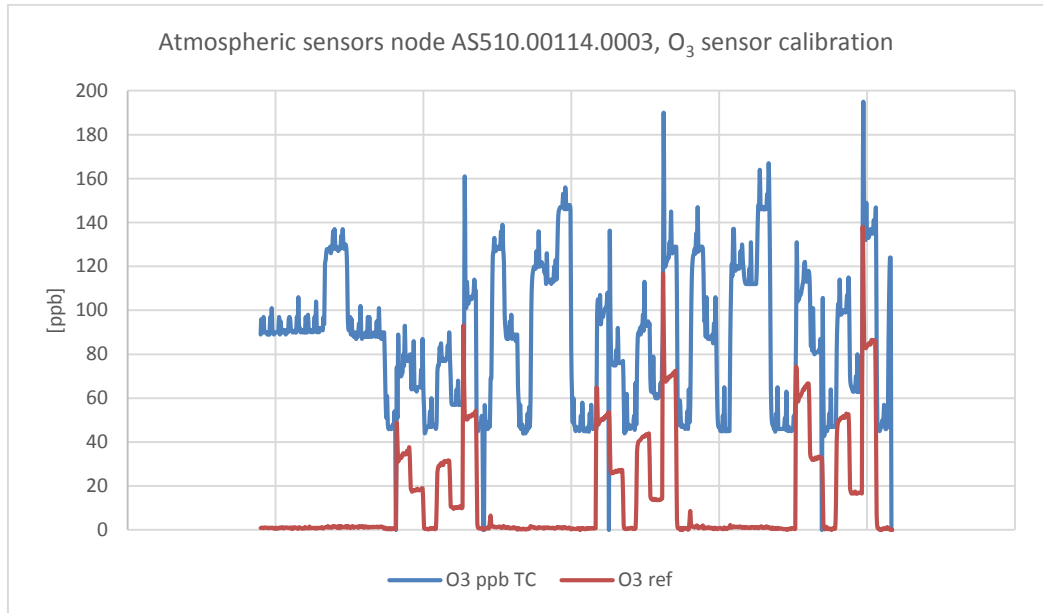

Ateknea LEO

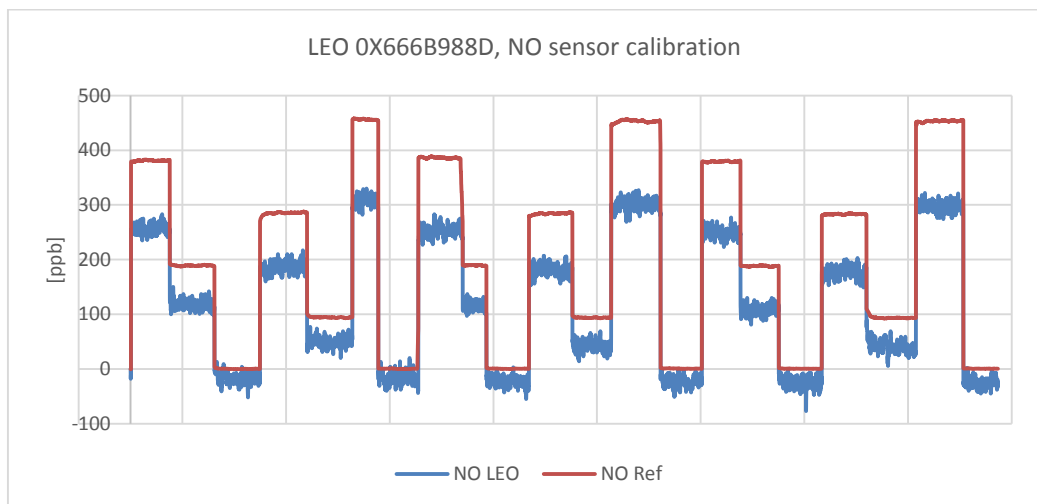
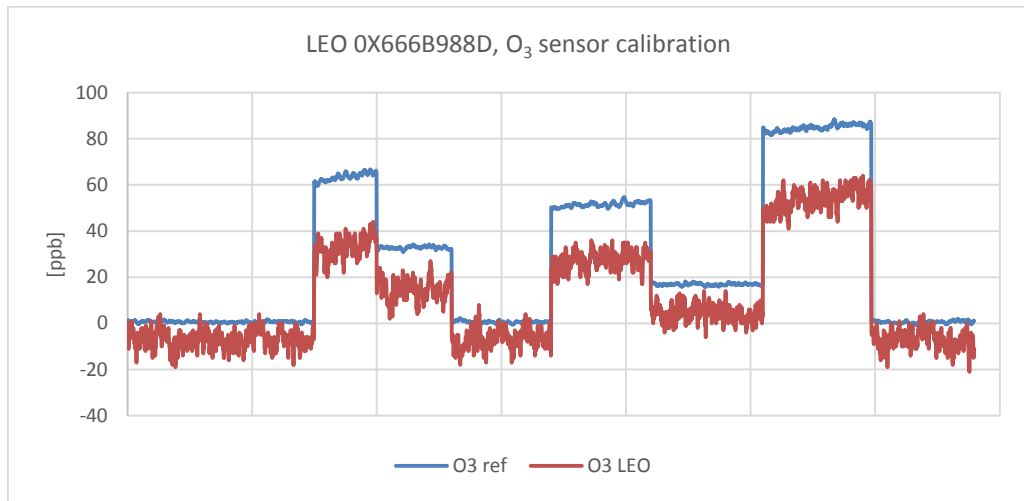

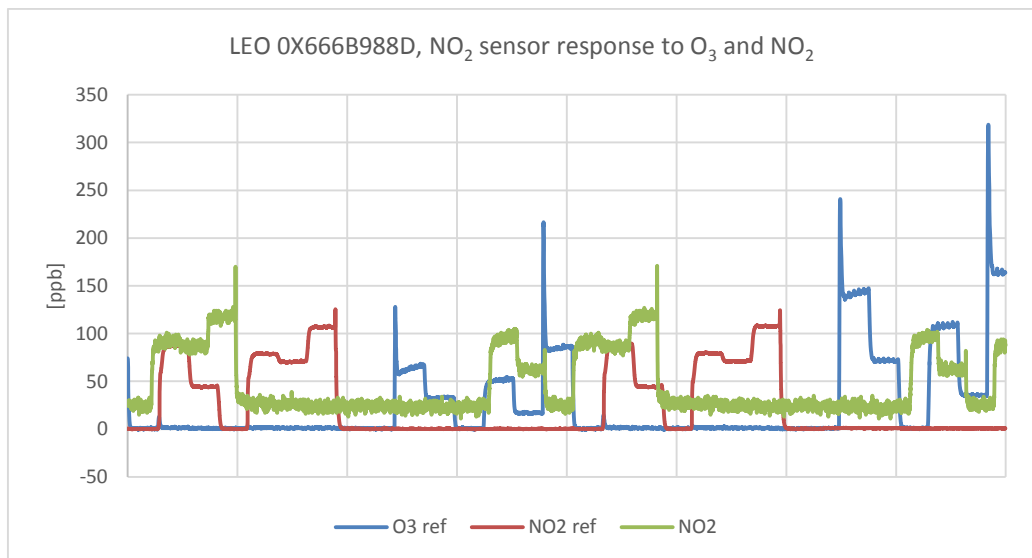
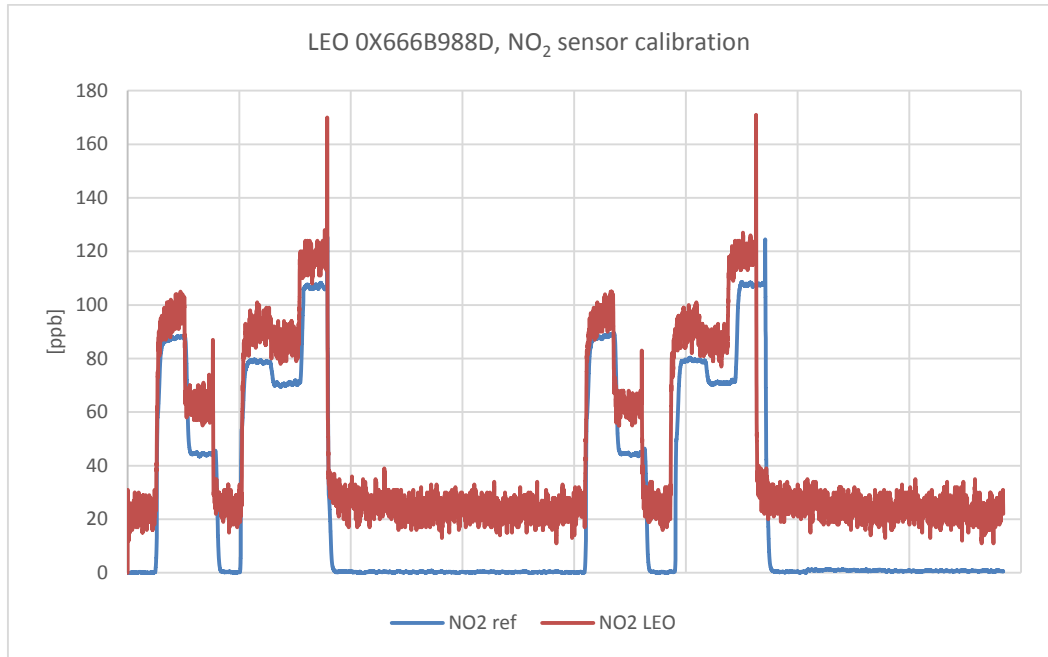

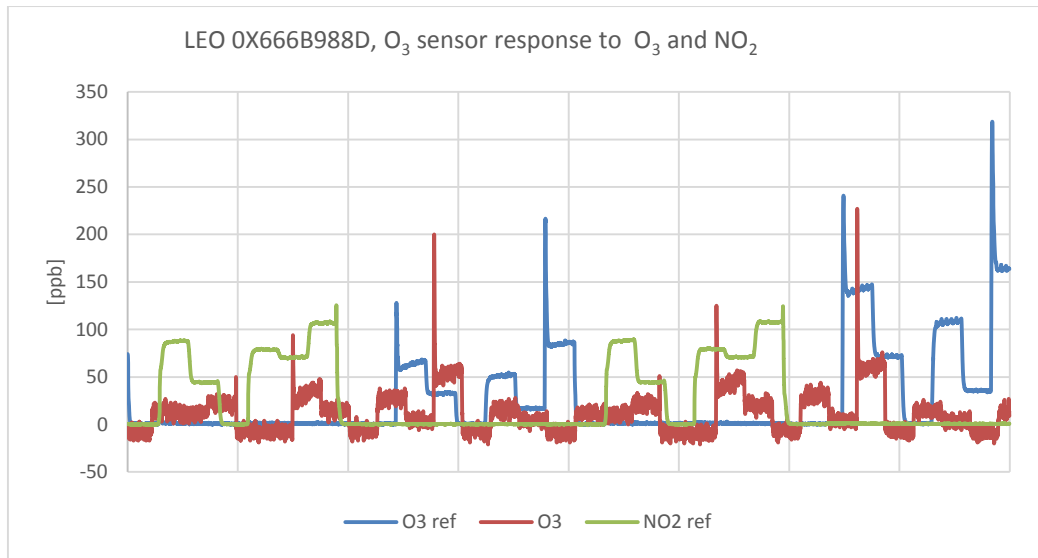

C. Summary of Edinburgh WP2 sensor field tests

Edinburgh AQMesh pod reference monitoring station co-location experiments

- 24 AQMesh pods (pods) were provided to Edinburgh.
- Air Quality Monitors kindly allowed access to various air quality reference monitoring stations (RMSs) in the Central belt of Scotland.
- Pods were located at reference monitoring stations for period approximately 20/3/15 – 29/5/15
- Reason for this shorter co-location time period than other sites as:
 - Understood that there was a need to maximise period of installation at the identified final sampling sites and;
 - Agreement from local authority had been granted to install the pods on given lampposts. We did not wish to delay the installation process.
- A number pods were co-located at the various RMSs (ranging from 2 to 6).
- The RMSs ranged from roadside to urban background
- Pods were ALL positioned within 1m of the sampling inlet of the RMSs.
- Although pods logging various pollutants these were not all monitored at the reference monitoring stations – **only possible to give results for NO and NO₂**.
- Data from pods provided via Envirologger, data from RMSs provided from www.scottishairquality.co.uk. This data may be subject to ratification at a later date
- Analysis of correlation coefficients; offset and slope undertaken as per instructions provided in AQMesh manual (which is given to all customers of the devices). These values will then be entered into Envirologger to allow for necessary offset and corrections to be applied to the data (as supplied to the user via Envirologger).
- Previous results circulated to WP8 early Aug and then Sept 2015. Following yet further discussions with Air Monitors, further data has been removed, analysis undertaken and updated results obtained. A very time consuming and tedious process.
- Details of RMSs used in colocation experiments obtained from www.scottishairquality.co.uk are provided in Appendix 1. The RMSs were all assigned as being 'roadside'.
- Details of the results are not provided here.

Where the AQMesh pods are now

- Following permission being granted by City of Edinburgh Council the AQMesh pods are installed in various locations in Edinburgh. 22 of the pods are located on street lamp posts; 2 of them are located at reference monitoring stations.
- For the two located at reference monitoring stations we will be undertaking further co-location analysis.
- Battery changes have taken place on all pods so theoretically should be able to collect data for 6 months.
- PROBLEM – we have had to date 6 sensor failures in past month, likely to be due to Winter weather and weather inversions. Fear that there may be more.
- Advised that in the event of a sensor changes that pods should be relocation at a reference monitoring site or another pod for 'calibration'. This presents various issues of follows:

- Movement of pod, rebasing period, collection of sufficient data to allow comparison, then redeployment back at designated location will take around one month. The battery life is limited.
- We can't continually go back and forth to reference monitoring stations to co-locate other pods – goodwill only goes so far.
- We can't co-locate pods with other pods on lamp posts due to permissions, lamp post structural integrity.
- Finally, the time and resources required to move pods from lampposts to monitoring sites and back again is prohibitive.
- The pods are located in public places. Despite great care being taken to avoid damage, vandalism, two have been damaged although this should now have been fixed. A data cable broke on another pod, reason unknown.

Ateknea personal sensors

- Box of sensors received at Edinburgh
- Due to efforts being focussed on dissemination of long air quality perception, apps etc these have not yet been tested.
- These will undergo testing / piloting by a core selection of persons who perhaps better understand the experimental nature and limitations concerning the use of such devices. We would therefore propose to ask members of the IOM, friends and family, members of the Advisory Group to trial the devices and provide feedback. Prior to this there will be some co-location and side-by-side testing of the devices.
- Ethics approval has been granted for the use of the personal devices by participants

RMSs Site details

Alloa

http://www.scottishairquality.co.uk/latest/site-info?site_id=ALO2#site_id=ALO2&view=details

Environment Type	Roadside
Coordinates (Lat/Long)	56.117343, -3.791818
Altitude	21m
Kerb Distance	Not Available
Site Comments	The site is located on the pavement adjoining the Alloa Ring Road (A907). This location has been chosen as 'worst case', due to the busy road, pedestrian crossing and residential properties nearby

Dunfermline

http://www.scottishairquality.co.uk/latest/site-info?site_id=DUNF

Environment Type	Roadside
Coordinates (Lat/Long)	56.073830, -3.448620
Altitude	89m
Kerb Distance	2
Site Comments	The nearest road is 2m from the site.

Rosyth

http://www.scottishairquality.co.uk/latest/site-info?site_id=ROSY

Environment Type	Roadside
Coordinates (Lat/Long)	56.036243, -3.417582
Altitude	27m
Kerb Distance	4
Site Comments	The nearest road is 4m from the site

Newton

http://www.scottishairquality.co.uk/latest/site-info?site_id=WLN4

Environment Type	Roadside
Coordinates (Lat/Long)	55.983925, -3.455939
Altitude	91m
Kerb Distance	1.5
Site Comments	The site is located on the A904, Newton. The nearest road is 1.5m from the site

Linlithgow

http://www.scottishairquality.co.uk/latest/site-info?site_id=WLC1

Environment Type	Roadside
Coordinates (Lat/Long)	55.976710, -3.597310
Altitude	57m
Kerb Distance	Not Available
Site Comments	Located on High Street (A803), Linlithgow

Uddingston

http://www.scottishairquality.co.uk/latest/site-info?site_id=SL06

Environment Type	Roadside
Coordinates (Lat/Long)	55.818357, -4.081839
Altitude	48m
Kerb Distance	2
Site Comments	Located on Main Street, Uddingston (B7071) at the junction with Bellshill Road (B756). The nearest road is 2m from the site

D. Summary of Ostrava and Prague Field Trial

Biomonitoring campaigns in Ostrava: first campaign (21 November to 1 December, 2013), second campaign (3 to 13 September, 2015) and a third campaign in winter 2016.

Instrumentation: Personal sampler PV 1,7 (URG Corp, USA), stationary sampler (High Volume Air Sampler ECO-HVS3000, Ecotech, Australia), GEOTECH, Ateknea.

Measured pollutants: PM_{2.5}, PAHs, NO, NO₂, CO, O₃, T, PT and RH.

Geotech tested from 21.11.2014 in Prague, later in Ostrava-Poruba reference station (first version, × 2). From 18.4.-30.9.2015 we tested a second version of Geotech instruments (× 16) at Ostrava Poruba reference station. Data are currently being analysed.

We are waiting for the new set of batteries for Geotech samplers with the aim to deploy in Ostrava in December or beginning of 2016. In the beginning of 2016 we are planning our third biomonitoring campaign using ATEKNEA personal sensors.

One Ateknea sensor node was tested in Prague in April, 2015. There is plan to further test eight more units in December 2015 which will be used for the biomonitoring in Ostrava in 2016.

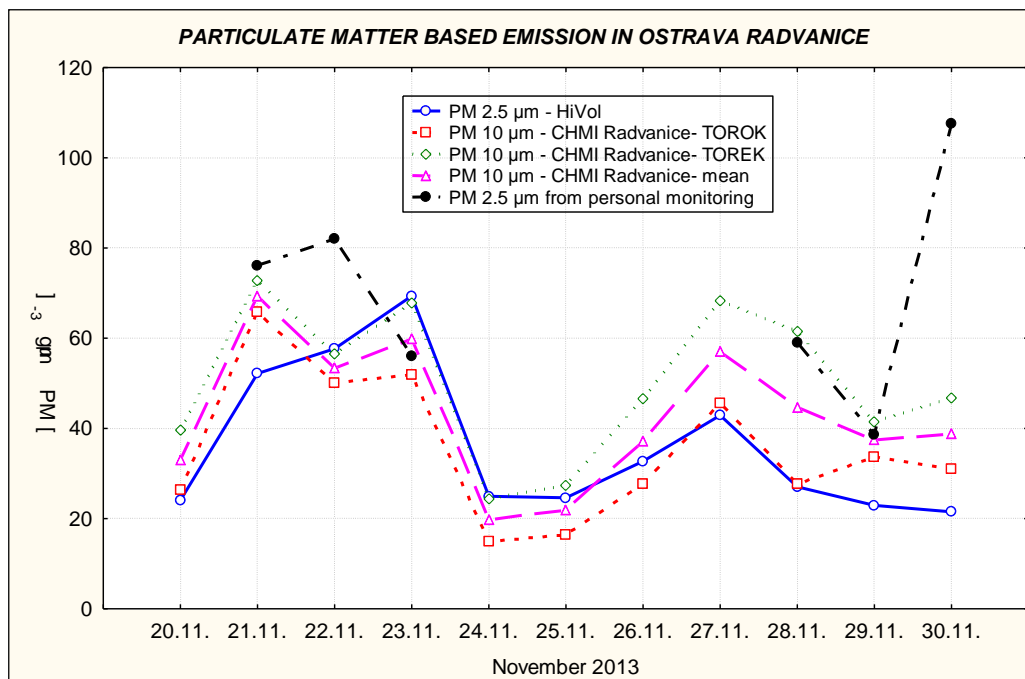

Figure D1. Personal and static monitoring in Ostrava 2013

Available data:

Table D1. First biomonitoring campaign in Ostrava 2013 (PM in ug/m³, PAHs in ng/m³)

	PM2.5	PM10	BaP	cPAHs	PAHs
Outdoor	35,41	35,51	5,28	34,26	60,04
Personal	68,79		5,45	28,17	34,95

Table D2. Correlations of personal monitoring 2013

	Valid N	Spearman koef	p-level
PM 2.5 & BC	70	-0.409984	0.000424
PM 2.5 & BC	35	-0.385154	0.022325
PM 2.5 & Phenanthrene	35	0.246437	0.153549
PM 2.5 & Anthracene	35	0.298658	0.081379
PM 2.5 & Fluoranthene	35	0.212720	0.219874
PM 2.5 & Pyrene	35	0.266171	0.122217
PM 2.5 & Benz(a) anthracene	35	0.343417	0.043405
PM 2.5 & Chrysene	35	0.342485	0.044015
PM 2.5 & Benzo(b) fluoranthene	35	0.367227	0.029999
PM 2.5 & Benzo(k) fluoranthene	35	0.362185	0.032510
PM 2.5 & Benzo(a)pyrene	35	0.386862	0.021688
PM 2.5 & Dibenz(a,h)anthracene	35	0.384354	0.022629
PM 2.5 & Indeno(1.2.3.cd)pyrene	35	0.384761	0.022474
PM 2.5 & Indeno(1.2.3.cd)pyrene	35	0.365826	0.030680
PM 2.5 & Coronene	35	0.422387	0.011482
BC & PM 2.5	35	-0.385154	0.022325
BC & Phenanthrene	35	-0.366174	0.030510
BC & Anthracene	35	-0.881232	0.000000
BC & Fluoranthene	35	-0.858505	0.000000
BC & Pyrene	35	-0.869017	0.000000
BC & Benz(a) anthracene	35	-0.881513	0.000000
BC & Chrysene	35	-0.884298	0.000000
BC & Benzo(b) fluoranthene	35	-0.891597	0.000000
BC & Benzo(k) fluoranthene	35	-0.897199	0.000000
BC & Benzo(a)pyrene	35	-0.927936	0.000000
BC & Dibenz(a,h)anthracene	35	-0.807777	0.000000
BC & Indeno(1.2.3.cd)pyrene	35	-0.939141	0.000000
BC & Indeno(1.2.3.cd)pyrene	35	-0.929972	0.000000
BC & Coronene	35	-0.927711	0.000000

Table D3. Correlations personal and outdoor monitoring 2013

HiVOL PM2.5 & HiVOL PAU	N	Spearman r	p-level
PM2.5 HiVOL & Phenanthrene	12	0,464	0,1287
PM2.5 HiVOL & Anthracene	12	0,462	0,1304
PM2.5 HiVOL & Fluoranthene	12	0,548	0,0649
PM2.5 HiVOL & Pyrene	12	0,600	0,0392
PM2.5 HiVOL & Benz(a)anthracene	12	0,743	0,0057
PM2.5 HiVOL & Chrysene	12	0,783	0,0026
PM2.5 HiVOL & Benzo(b) fluoranthene	12	0,823	0,0010

PM2.5 HiVOL & Benzo(k) fluoranthene	12	0,783	0,0026
PM2.5 HiVOL & Benzo(a)pyrene	12	0,811	0,0014
PM2.5 HiVOL & Dibenz(a,h)anthracene	12	0,849	0,0005
PM2.5 HiVOL & Benzo(g,h,i)perylene	12	0,853	0,0004
PM2.5 HiVOL & Indeno(1.2.3.cd)pyrene	12	0,862	0,0003
PM2.5 HiVOL & Coronene	12	0,856	0,0004

PM10 CHMI & personal monitoring PAU	N	Spearman r	p-level
PM10-TORxx mean & Phenanthrene	35	0,063	0,7191
PM10-TORxx mean & Anthracene	35	0,746	0,0000
PM10-TORxx mean & Fluoranthene	35	0,767	0,0000
PM10-TORxx mean & Pyrene	35	0,763	0,0000
PM10-TORxx mean & Benz(a)anthracene	35	0,749	0,0000
PM10-TORxx mean & Chrysene	35	0,780	0,0000
PM10-TORxx mean & Benzo(b) fluoranthene	35	0,748	0,0000
PM10-TORxx mean & Benzo(k) fluoranthene	35	0,759	0,0000
PM10-TORxx mean & Benzo(a)pyrene	35	0,773	0,0000
PM10-TORxx mean & Dibenz(a,h)anthracene	35	0,579	0,0003
PM10-TORxx mean & Benzo(g,h,i)perylene	35	0,779	0,0000
PM10-TORxx mean & Indeno(1.2.3.cd)pyrene	35	0,762	0,0000
PM10-TORxx mean & Coronene	35	0,802	0,0000

Table D4. Tests of 2 Geotech in Prague 2014

Period	Values	Valid N	Spearman R	t(N-2)	p-level	
27.11.-15.12.2014	611150	NO2_HORIBA & NO2_FinalReading_611150	1821	0,360	16,449	0,0000
		NO_HORIBA & NO_FinalReading_611150	1820	0,687	40,309	0,0000
		O3_HORIBA & O3_FinalReading_611150	1764	0,737	45,703	0,0000
		CO_HORIBA & CO_FinalReading_611150	1820	0,698	41,532	0,0000
		SO2_HORIBA & SO2_FinalReading_611150	1819	0,610	32,816	0,0000
	612150	NO2_HORIBA & NO2_FinalReading_612150	1821	0,519	25,908	0,0000
		NO_HORIBA & NO_FinalReading_612150	1821	0,737	46,510	0,0000
		O3_HORIBA & O3_FinalReading_612150	1764	0,747	47,229	0,0000
		CO_HORIBA & CO_FinalReading_612150	1820	0,607	32,591	0,0000
		SO2_HORIBA & SO2_FinalReading_612150	1819	0,671	38,532	0,0000
21.11.-26.11.2014	611150	NO2_HORIBA & NO2_FinalReading_611150	-	-	-	-
		NO_HORIBA & NO_FinalReading_611150	-	-	-	-
		O3_HORIBA & O3_FinalReading_611150	273	0,061	1,004	0,3164
		CO_HORIBA & CO_FinalReading_611150	470	0,792	28,042	0,0000
		SO2_HORIBA & SO2_FinalReading_611150	510	0,387	9,456	0,0000
	612150	NO2_HORIBA & NO2_FinalReading_612150	-	-	-	-
		NO_HORIBA & NO_FinalReading_612150	291	0,630	13,801	0,0000
		O3_HORIBA & O3_FinalReading_612150	303	0,155	2,729	0,0067
		CO_HORIBA & CO_FinalReading_612150	463	0,785	27,190	0,0000
		SO2_HORIBA & SO2_FinalReading_612150	512	0,388	9,519	0,0000
total	611150	NO2_HORIBA & NO2_FinalReading_611150	1822	0,359	16,422	0,0000
		NO_HORIBA & NO_FinalReading_611150	1821	0,687	40,315	0,0000
		O3_HORIBA & O3_FinalReading_611150	2037	0,680	41,894	0,0000
		CO_HORIBA & CO_FinalReading_611150	2290	0,717	49,200	0,0000
		SO2_HORIBA & SO2_FinalReading_611150	2329	0,515	28,981	0,0000
	612150	NO2_HORIBA & NO2_FinalReading_612150	1822	0,333	15,084	0,0000
		NO_HORIBA & NO_FinalReading_612150	2112	0,744	51,178	0,0000
		O3_HORIBA & O3_FinalReading_612150	2067	0,695	43,964	0,0000
		CO_HORIBA & CO_FinalReading_612150	2283	0,645	40,312	0,0000
		SO2_HORIBA & SO2_FinalReading_612150	2331	0,494	27,420	0,0000

Table D5. Collocation of GEOTECH pods in Ostrava 2015

OSTRAVA 18.4.-27.5.2015												
Pod	CO			NO			NO2			O3		
	Slope	Offset	r2	Slope	Offset	r2	Slope	Offset	r2	Slope	Offset	r2
693150	0,58	-74	0,46	0,96	16	0,31	1,3	26	0,11	0,7	10	0,47
707150	0,57	-79	0,45	1,3	22	0,19	1,7	29	0,15	-0,039	36	0,0043
734150	0,61	-92	0,49	0,75	29	0,04	0,84	4,7	0,13	0,036	30	0,0027
735150	0,62	-94	0,5	1,3	17	0,37	0,18	32	0,004	0,099	32	0,028
745150	0,55	-78	0,48	1,1	19	0,25	1,1	18	0,19	0,98	25	0,58
747150	0,63	-76	0,39	1,2	20	0,23	1	15	0,16	0,8	24	0,62
749150	0,65	-92	0,49	1	22	0,15	1,4	26	0,13	1,2	66	0,66
752150	0,6	-91	0,49	0,99	15	0,31	0,28	22	0,023	0,14	16	0,067
778150	0,56	-87	0,5	0,4	12	0,36	0,19	44	0,0034	0,36	18	0,27
788150	0,52	-76	0,48	0,8	8	0,79	-0,7	159	0,0064	0,17	18	0,033
800150	0,5	-84	0,45	0,69	38	0,078	0,96	22	0,095	1,1	10	0,74
801150	0,58	-85	0,49	1,2	33	0,13	0,6	33	0,036	0,43	43	0,25
802150	0,52	-91	0,5	0,73	26	0,14	0,97	38	0,061	0,68	9,7	0,46
813150	0,56	-87	0,49	0,56	9,2	0,6	0,17	41	0,0032	0,5	31	0,32
826150	0,54	-86	0,46	0,84	29	0,14	0,54	41	0,036	0,14	36	0,017
844150	0,55	-87	0,46	1,6	60	0,056	0,35	33	0,017	0,73	13	0,31

E. Summary of Barcelona Field Trial

Both the Geotech static sensor nodes (AQMesh pods) and the Ateknea mobile sensor nodes (Little Earth Observatories, LEOs; previously referred to in the pilot study as ‘personal sensor packs’, PSPs) were tested during the pilot and full study phases. These phases occurred in mid-2014 and mid-2015, respectively, and ran for a period of several months each. For the testing, they were deployed at the principal Barcelona office (located in the Palau Reial zone) of the national scientific research body (Superior Council for Scientific Research, CSIC). Within the grounds of this office there is a state government-run regulatory air quality monitoring station as depicted in fig E1 (a & b). This station monitors the same species as the pods and LEOs, allowing for correlation analyses to determine the performance of the sensors. As such, we have comparative data for nitrogen monoxide, nitrogen dioxide and ozone over several months continuously, for both the pilot and main study period. Despite some sensor failures requiring replacements and thus downtime (of the failed-sensor species, and all sensor species when batter unplugged, respectively), the majority of data was received from the pod at the server end. While the static nodes correlated reasonably-well with the regulatory equipment, the LEOs did not perform as well. Both types of nodes are now awaiting to be hosted throughout the city, with the expectation that they will be deployed and operation, providing live data, before the end of the year. The pods will go to resident homes (fig E1 (c)) and some government buildings, according to the demands of the air quality modeling initiative, for a period of six months (limited by battery life and host interest/capacity). The LEOs will go to hospital outpatients (fig E1 (d)), who are of particularly interest due to their expected sensitivity to elevated air pollution levels, for a period of one week or more (depending on host interest and capacity).



Figure E1. Pictures summarising outdoor reference monitoring stations (a&b), proposed deployment locations of AQMesh pods (c) and the Ateknea/LEO pod (d).

F. Summary of Ljubljana sensor field tests

AQMesh pods reference monitoring station co-location experiments:

The Ljubljana Empowerment Initiative used 17 static platforms from Geotech/AQMesh for outdoor air quality monitoring. All 17 pods were located at the reference monitoring site (RMS) Ljubljana-Bežigrad operated by Slovenian Environmental Agency (www.arso.gov.si/en) during the 15/04/2015 – 10/10/2015 period. AQMesh pods were all positioned within 1m of the sampling inlet of the RMS (see Figure F1 below). Analysis of correlation coefficients, offset and slope was then undertaken for the whole collocation period as well as on monthly basis. Instructions provided in AQMesh manual were followed.

AQMesh pods used: 5 pilot phase pods (serials: 125, 127, 128, 131, 133) and 12 new ones (serials: 685, 689, 692, 699, 721, 753, 783, 797, 830, 831, 838, 685, 876)

RMS Site details

http://www.arso.gov.si/zrak/kakovost%20zraka/podatki/amp/e00_g_1.html

Name	Ljubljana Bežigrad
LAT/LON	46.06159/14.51917
Altitude	295 m
Above Ground Level	3.5 m
Parameters measured	T, RH, AP, CO, O ₃ , SO ₂ , NO ₂ , NO _x , PM10
Environment type	The site is classified as an urban background site. It is located at the premises of the Agricultural institute of Slovenia and is surrounded by residential quarters mostly. There is no much traffic in the area with the nearest road cca. 100 m from the site. The average temperature during field trials was 12.5 °C.



Figure F1: Pictures of the measurement set-up of 17 AQMesh pods co-located together with the reference air quality station in Ljubljana.

Atmospheric Sensors collocation testing:

The Ljubljana Empowerment Initiative used 12 Atmospheric Sensor indoor units. All units were collocated for the period of three months (August-October 2015). Initially, during August all 12 units were collocated in an office located at the premises of the Jožef Stefan Institute in Ljubljana. During this time T, RH and CO₂ concentrations measured by AS units were compared with the results obtained by commercially available NetAtmo weather station (<https://www.netatmo.com/en-US/site>). Later on, starting with September, three AS units were moved and collocated together with the NetAtmo station in one of the classrooms at Spodnja Šiška elementary school in Ljubljana.

Plan forward:

- *AQMesh* – After offset and slope adjustments for each individual pod, these will be deployed across Ljubljana at previously selected locations according to the deployment plan and in support of the modelling (data fusion) needs. The deployment is foreseen for the end of November – beginning of December 2015 period.
- *Atmospheric Sensors* – All 12 units are already deployed in the three schools involved in WP3 activities.
- *LEOs* – After collocation of the units which is foreseen for the end of November – beginning of December 2015 period, the units will be tested with previously identified groups of volunteers.

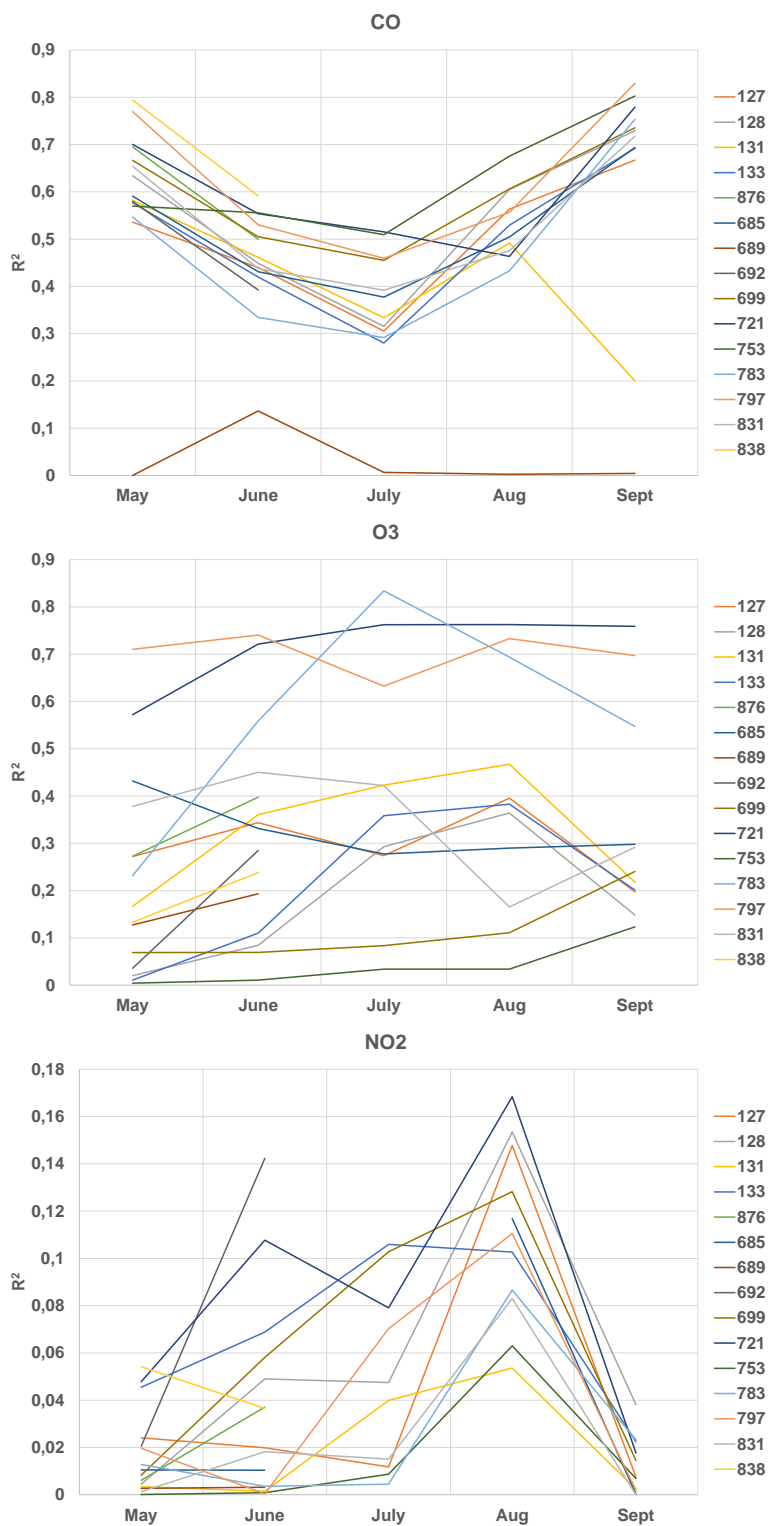

Figure F2: Correlation between reference monitoring station and AQMesh pods over time for CO, O₃ and NO₂

G. Summary of Vienna sensor field tests

In Vienna the preparation for the main study are in full process. The experiences from the pilot study showed that:

- (i) the Geotech pods did not live up to their expectations concerning correlations with a collocated official air quality monitoring station.
- (ii) the first version of personal pods were rejected as not ready to use.

The consequences from (i) was that the Vienna air quality authorities cancelled their support for the project and thus no more collocations are possible at the moment.

For the second issues a new version of personal sensors were developed and delivered by ATEKNEA (Little Environmental Observatories, LEOs).

These LEOs are currently under investigation before they are going to be used for the duration of the main study. At the moment investigations are carried out concerning calibration (do all sensors measure the same, in and outdoors) and how is the usability concerning smartphone connection and apps. After some problems the connectivity via Bluetooth is now quite stable. First analysis of calibration period shows reasonable results. Still one main concern is the rapid consumption of smart phone battery, which might have a negative effect for the deployment with volunteers. Two main groups are included in the main study with the LEOs. The Friend of the Earth branch in Vienna which is called GLOBAL 2000 will provide volunteers from their internship program and distribute information and the long questionnaires via their channels. Cyclists will be involved as well using the LEOs for their daily commute. Another group of volunteers will come from the universities where earth science students will be offered to use the LEOs and describe their experiences as part of a seminary work during next spring/summer.

Concerning the Geotech pods, due to no access to official AQ monitoring sites we have to assume that the reasonable correlations found in other cities are true for the Vienna case as well. All Geotech pods are at the moment in one place and monitored for calibration purpose. Overall the results need a closer analysis, which is in progress. The sensors showed some failures but replacements have been delivered and will be installed in the near future together with the new batteries packs once they have arrived.

H. Summary of Belgrade sensor field tests

Validation procedures and Field Campaigns of low cost platforms during CITI-SENSE main campaign in Belgrade

Experience and preliminary results of field validation of low cost platforms for use in WP2 Urban Air and WP3b Indoor Air in Schools main case studies in Belgrade:

- Co-location in the field has been performed by Institute VINCA (Serbia). The following data has been used as reference data for intercomparison/calibration purposes:
- Pollutants level from Automatic Monitoring Stations-AMS Zeleno Brdo and Stari Grad (with resolution of 1 minute) for t, RH, p, NO, NO₂, CO, O₃, PM_{2.5} and PM₁₀ that belong to National Network for monitoring air quality running under Ministry of Agriculture and Environment Protection of Republic of Serbia, Agency for Environmental Protection –SEPA. Automatic stations are equipped with Grimm monitors for particulate matter and thermo monitors for gases.
- In about 40 days 24h gravimetric mass data collected with reference LVS samplers (provided by Institute VINCA),
- During part of co-location studies data on ultrafine, fine and coarse particles were recorded with TSI Nanoscann 3910 and OPC 3330 counters (provided by Institute VINCA) with resolution of 1 minute.
- Institute VINCA (Serbia) is working on device validation, data presentation and statistical analysis and results will be available in upcoming weeks.
- Since middle of May, when we start campaign of co-location AQ pods with AMS, there were no data available for PM_{2.5} and PM₁₀ for AQMesh. PM fractions for AQMesh are available now for the period when we performed our campaign. We collected in parallel data with 3 different PM low cost sensors. That is important for manuscript(s) that we plan to prepare and submit in the upcoming period.
- We stopped collecting data on 17/10/2015 with AQMesh. At the moment, only one pod is measuring. In the period between 15/9-15/10 almost all batteries expired. So, the batteries work about 4.5 months. One of the AQMesh devices never established any signal during the second campaign.
- Analysis of collected data and calibration Atmospheric pods, as well as EB700 and LEO are also in progress.

Table H1. Timeline of activates for validation of deployed of static and personal devices for the Belgrade CITI-SENSE main case study

Dates	Status	Comment	Action
30/03/2015.	Geotech delivered 1 AQMesh platform	Only 1 platform was deliver by mistake	
30/03/2015.	Alphasense delivered with 10 NO2 and 10 O3 sensors.	Vinca plan to use EB700 10 pods for main campaign.	EB700, DNet, pods were used during pilot CITI-SENSE campaign. On Vinca's behalf Alphasense sent sensors to be replaced in 10 EB700 devices.
27/04/2015.	Geotech delivered 24 AQMesh pods		
05/04/2015.- 14/05/2015.	AQMesh collecting data in indoor environment in laboratory space at Institute Vinca.	After problems at the beginning for some devices connection with server established and data appear at Envirologger web page	AQMesh platforms check and installed in laboratory in Vinca.
14/05/2015.- 26/06/2015.	Campaign of collecting data for comparison within same type of pods (and between different	On 14/05/2015. start with installation of 25 AQMesh pods and 10 EB700 to be collocated at AMS Zeleno Brdo, in total	Sent mail to Envirologger to ask for PM sensors visualization and data access.

	devices collocated at AMS Zeleno brdo, urban residential station.	35 pods. Most of platforms were placed at terrace 50 m from ATM. Terrace is of similar height sampling inlet for pollutant at AMS. Identified that Envirologger start to show total count instead of PM2.5 and PM10 was previously shown. Some of AQMesh pods had problems with signal establishment and signal continuity. One of them almost all time didn't established signal.	During first campaign 25 AQMesh and 10 EKO700 pods were collocated next to automatic monitoring station (ATM) located in the yard of SEPA at Zeleno Brdo. Devices were check every two-three days. During camping at this location there were difficulties with signal establishment and signal breaks.
07/07/2015. 17/10/2015.	Campaign of collecting data for comparison within same type of pods and between different devices collocated at AMS Stari Grad, urban residential station.	On 07/07/2015. 25 AQMesh was collocated at AMS Stari Grad AQMesh were installed at roof of gum of elementary school. ATM is in same yard at distance of about 30 meters. Level of sampling	
17/07/2015.- 5/08/2015.	Delivering of Atmospheric platforms and providing with necessary plugs with fuses	-Alphasense deliver 12 Atmospheric platforms in second part of July 2015. -Alpasense delivered 2 cables that was missed week after devices. -There were not deliver UK plugs and fuses. There were provided through personal contact.	It was identified that there is only cables at not plug. Alpasense insist that it is necessary to connect cable to plug with fuse. Spent lot of time to complete all that is necessary for starting with collecting data.
07/08/2015.- 17/10/2015.	Campaign at automatic monitoring station Stari Grad for Atmospheric and EB700 devices.	12 Atmospheric and 10 EB700 platforms install at roof in cages next to collocated at AMS Stari Grad.	It was easy to follow signal for EB700 pods, but it was not possible to check signal for Atmospheric devices in real time.
15/07/2015. 15/09/2015.	Campaign of collecting PM1, PM2.5, PM10 with reference LVS samplers at ATM Stari Grad	Data will be used for comparison and additional calibration 24h average of PM low cost sensors	More than 40 days of PM fractions were collected
15/07/2015. 15/08/2015.	Campaign of collecting ultrafine, fine and coarse PM with TSI sizers and counters at ATM Stari Grad	Data will analyzed and used for comparison PM low cost sensor responses.	Still not identified volume of collected data. Will be analyzed in upcoming period.
07/2015.- 29/09/2015.	Delivered Obeo sensors	Obeo sensors still not working	We never see that Obeo radon sensors never establish signal. We use prepaid SIM card from 2 providers. We were in contact with Obeo. At the end of September 2015. Obeo inform us that problem is with their server. Data are transfer and store, but not possible to download. But, till now we don't have any news.
14/09/2015. 30/09/2015.	Delivered LEO by Ateknea and providing with Smart Phones	-Ateknea deliver 10 LEO platforms -Provided additional mobile phones	Studying how devices work.
05/11/2015. present	Campaign of collecting data with 11 LEO personal platforms for comparison within pods and between pods and reference monitors at AMS Gradski Zavod, traffic station.	Monitor for O3 stop to work at the end of October at Stari Grad. LEO devices are collocated with monitors that belong to Public Health Institute of Belgrade	Collecting data for personal sensors is much more complicated as it is necessary to fill batteries often. We don't have not capacity to plug in so much instruments at outdoor location where we have access.



Figure H1. Campaign of collocation at AMS Zeleno Brdo



Figure H2. Campaign of collocation at AMS Stari Grad

***AQMesh pods for CITI-SENSE main campaign:
Statistical analysis within 25 AQMesh (Geotech)platforms and EB700 devices (Dnet)***

An analysis of AQMesh platforms was done using descriptive statistics. In the period when the devices were co-located to the the automatic monitoring station (ATM) that belongs to the Serbian Agency for Environmental Protection (SEPA), the referent measurements from these monitoring stations were not provided yet. Therefore we have done the analysis related to AQMesh (Geotech) and EB700 (Dnet) instruments and primarily we were focused on their mutual correlation. The period in which analysis were conducted was from 19/05/2015 to 26/06/2015. The following is presented:

1. Figure H3. Graph of of measurement of each data during campaign each for all 25 AQMesh pods.
2. Table H2. Pearson correlation coefficients of each platform relative to all other platforms, for AQMesh podes and EB700
3. Figure H4. For each of monitor pollutants graph of mean of Pearson correlation coefficients of each platform relative to all the others for AQMesh podes and EB700

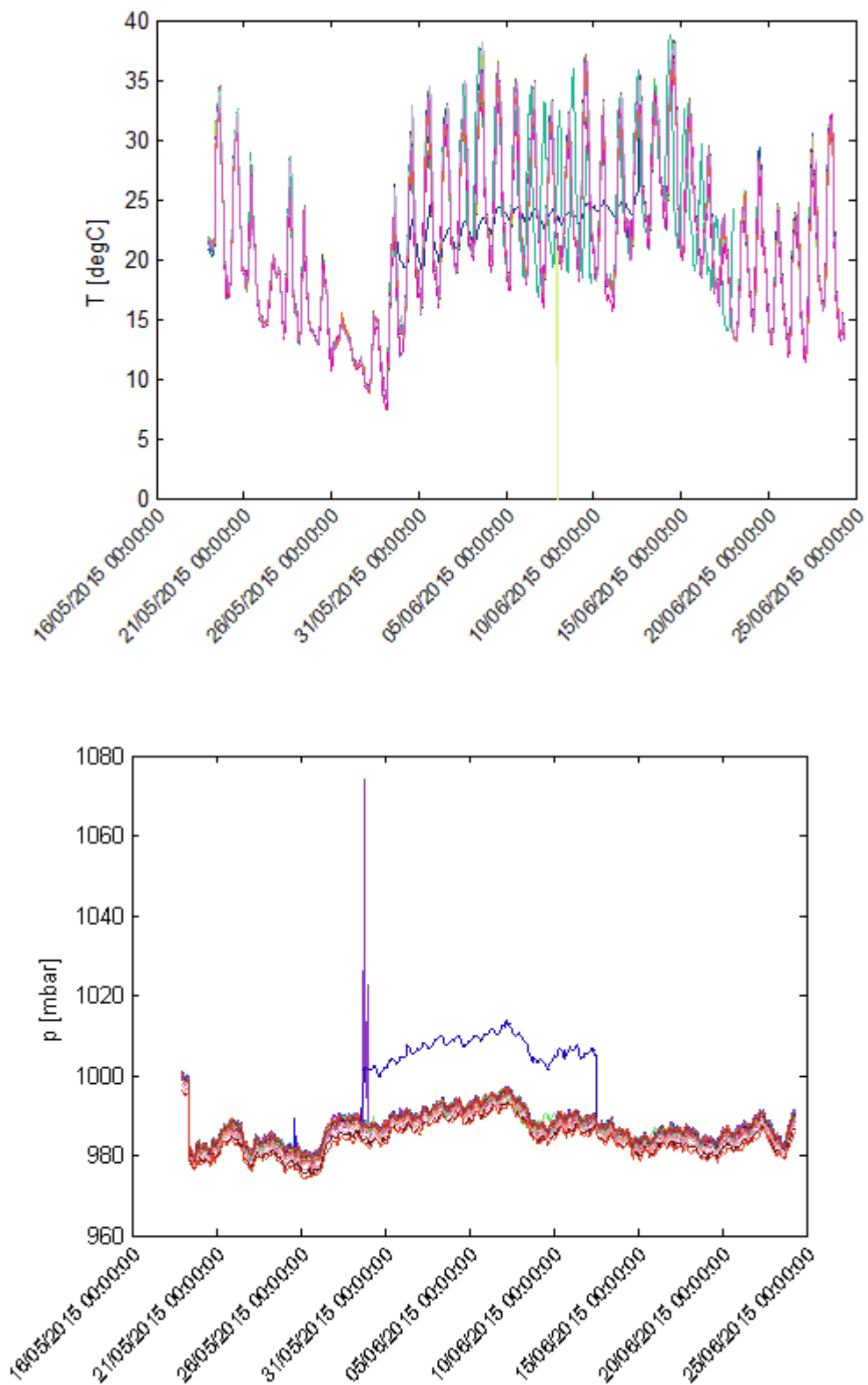

Figure H3. Graph of of measurement of each data during campaign each for all 25 AQMesh pods.

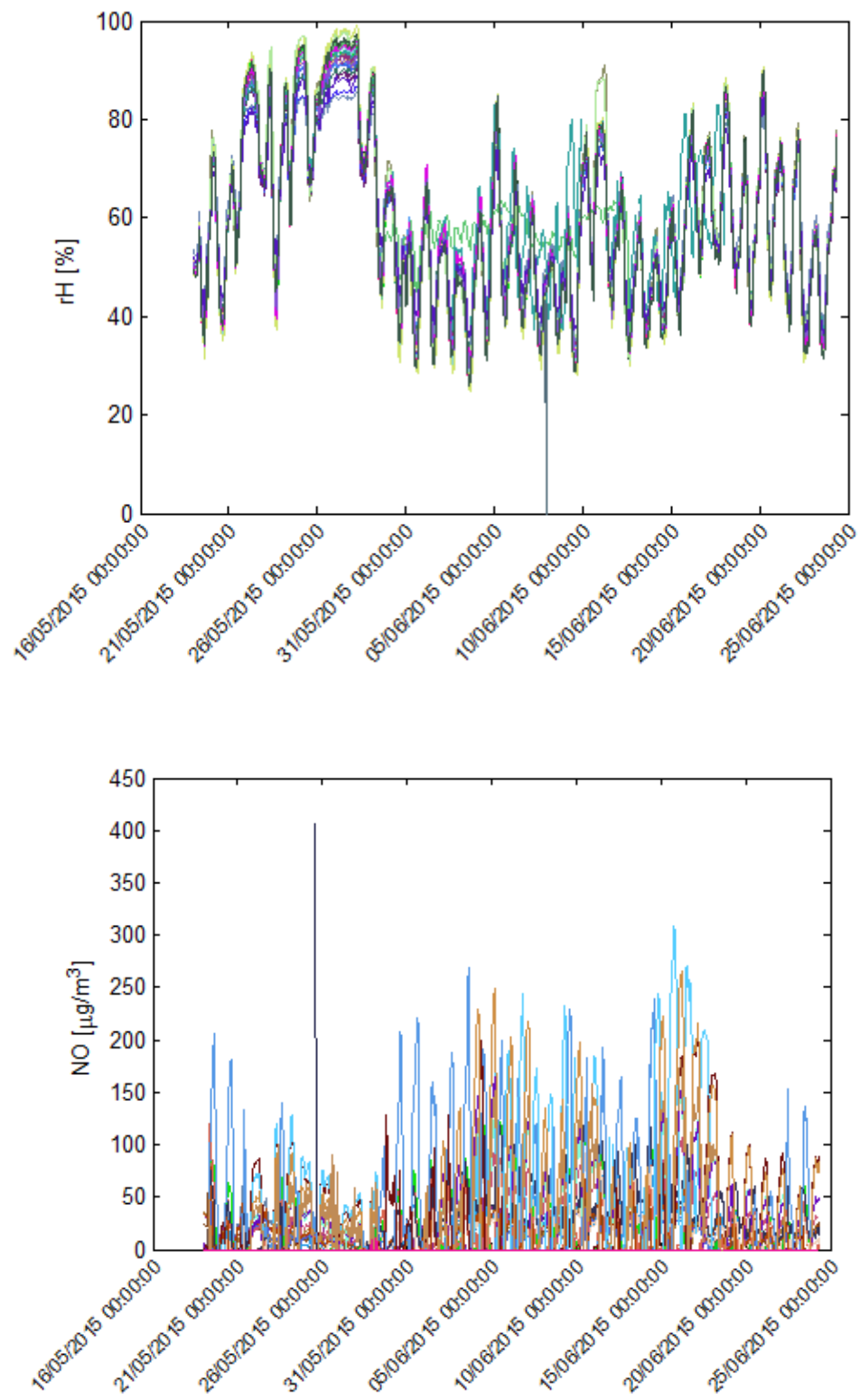

Figure H3 contd. Graph of measurement of each data during campaign each for all 25 AQMesh pods.

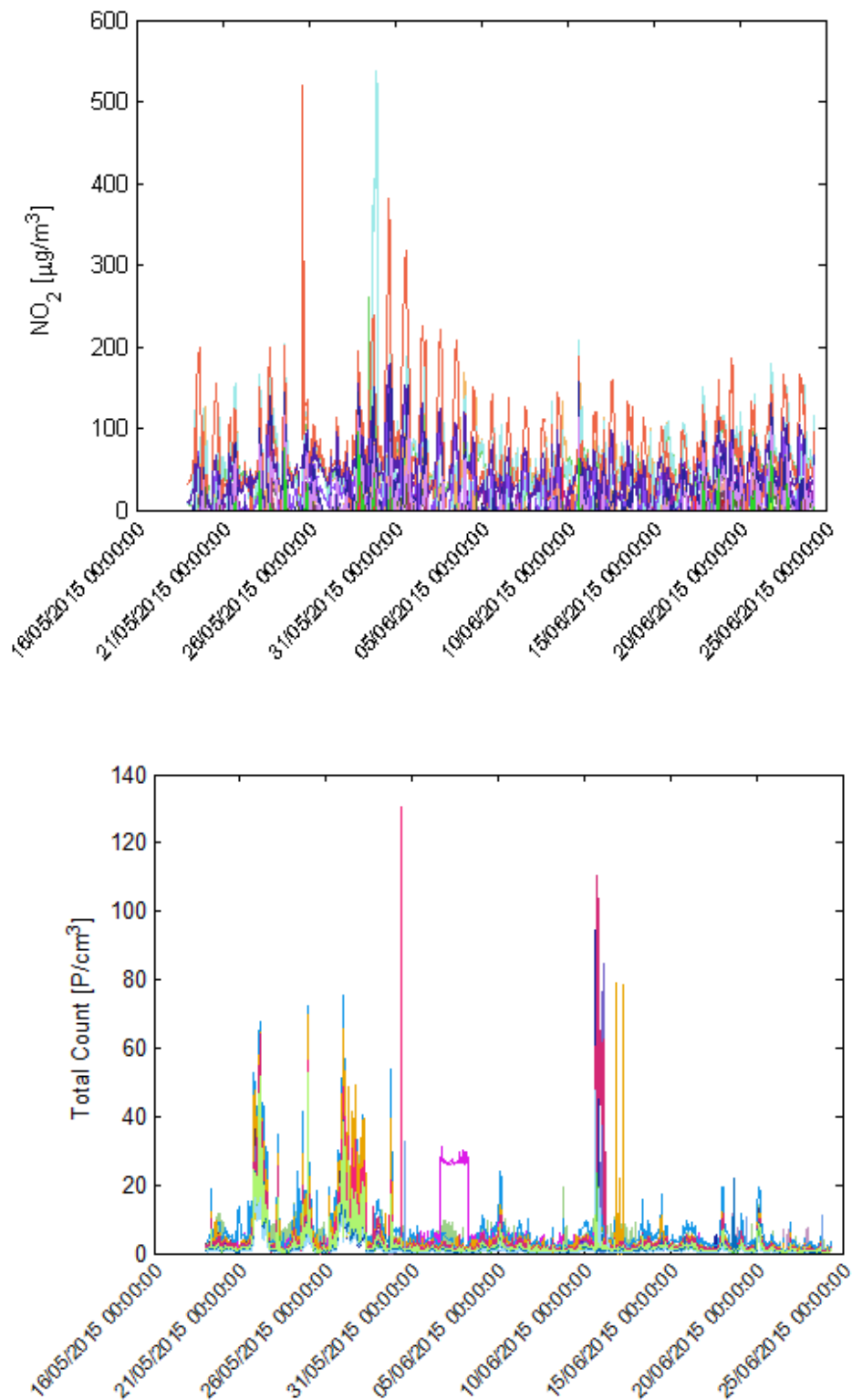

Figure H3 contd. Graph of of measurement of each data during campaign each for all 25 AQMesh pods.

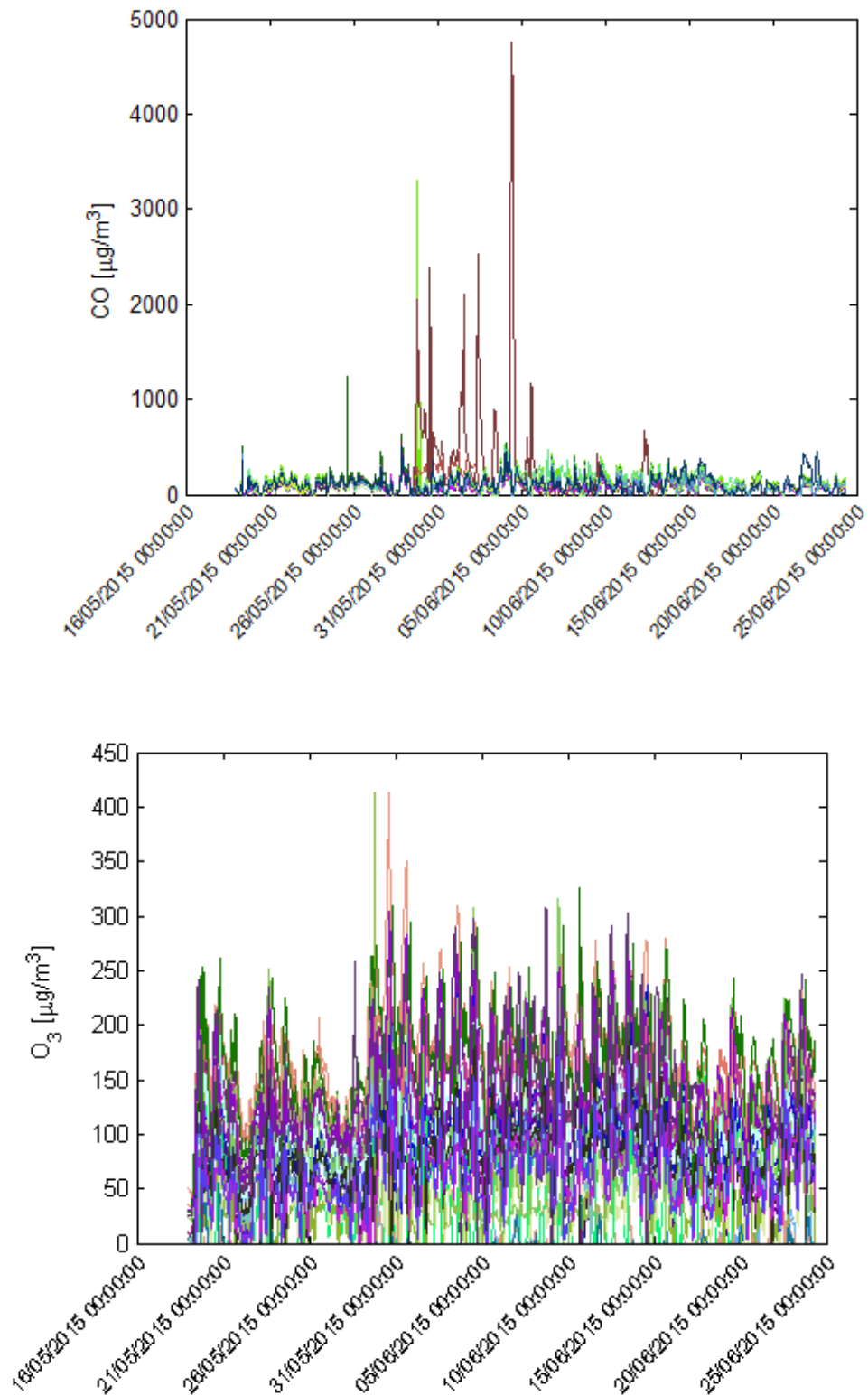

Figure H3 contd. Graph of of measurement of each data during campaign each for all 25 AQMesh pods.



ANNEX

D8.4 Sensor platforms enhancement

Table H2. Pearson correlation coefficients of each platform relative to all other platforms, for AQMesh nodes and EB700. NO₂ sensors integrated in AQMesh platform - Pearson correlation coefficient within 25 platforms, ATM Zeleno Brdo 19.5-26.6.2015.

PL No	695150	696150	702150	705150	714150	716150	722150	729150	730150	754150	763150	792150	809150	810150	812150	821150	827150	829150	839150	858150	859150	870150	872150	873150	875150	
695150	1,00																									
696150	0,94	1,00																								
702150	0,76	0,75	1,00																							
705150	0,81	0,82	0,94	1,00																						
714150	0,56	0,58	0,79	0,73	1,00																					
716150	0,67	0,68	0,73	0,67	0,77	1,00																				
722150																										
729150	0,96	0,96	0,80	0,86	0,63	0,73		1,00																		
730150	0,42	0,41	0,64	0,58	0,76	0,57		0,50	1,00																	
754150	0,52	0,46	0,46	0,38	0,50	0,82		0,53	0,39	1,00																
763150	0,54	0,45	0,44	0,37	0,43	0,72		0,55	0,34	0,92	1,00															
792150	0,56	0,56	0,70	0,59	0,83	0,89		0,62	0,66	0,68	0,60	1,00														
809150	0,43	0,43	0,57	0,49	0,73	0,73		0,50	0,74	0,54	0,47	0,89	1,00													
810150	0,38	0,35	0,37	0,29	0,42	0,71		0,42	0,32	0,91	0,90	0,59	0,48	1,00												
812150	0,26	0,26	0,42	0,36	0,58	0,38		0,30	0,74	0,25	0,22	0,52	0,67	0,22	1,00											
821150	0,72	0,72	0,78	0,73	0,76	0,97		0,79	0,63	0,80	0,73	0,86	0,72	0,68	0,39	1,00										
827150	0,57	0,57	0,77	0,69	0,90	0,83		0,64	0,81	0,57	0,50	0,94	0,89	0,50	0,61	0,83	1,00									
829150	0,40	0,39	0,58	0,48	0,75	0,71		0,46	0,75	0,50	0,44	0,89	0,99	0,44	0,72	0,68	0,88	1,00								
839150	0,26	0,28	0,38	0,35	0,53	0,47		0,32	0,73	0,32	0,28	0,54	0,71	0,27	0,80	0,48	0,63	0,66	1,00							
858150	-0,07	-0,05	-0,04	-0,05	-0,02	-0,04		-0,06	-0,02	-0,01	-0,01	-0,02	-0,02	0,00	-0,01	-0,05	-0,02	-0,02	-0,01	1,00						
859150	0,76	0,76	0,88	0,86	0,82	0,89		0,81	0,64	0,63	0,55	0,81	0,66	0,52	0,40	0,92	0,84	0,64	0,45	-0,03	1,00					
870150	0,78	0,78	0,85	0,84	0,78	0,92		0,86	0,65	0,70	0,65	0,82	0,68	0,59	0,40	0,97	0,83	0,65	0,47	-0,05	0,95	1,00				
872150	0,44	0,44	0,68	0,60	0,81	0,63		0,50	0,88	0,41	0,36	0,75	0,81	0,34	0,80	0,64	0,85	0,82	0,78	-0,02	0,66	0,65	1,00			
873150	0,73	0,74	0,89	0,89	0,85	0,87		0,81	0,71	0,59	0,52	0,80	0,68	0,47	0,43	0,91	0,86	0,65	0,48	-0,03	0,96	0,95	0,70	1,00		
875150	0,38	0,39	0,57	0,52	0,71	0,59		0,46	0,93	0,40	0,35	0,69	0,79	0,34	0,75	0,63	0,83	0,79	0,85	-0,01	0,61	0,63	0,89	0,67	1,00	
<0,3																										
0.3<0.6																										
0.6<0.9																										
>0.9																										



Table H2. Pearson correlation coefficients of each platform relative to all the others for AQMesh nodes and EB700, per pollutant. NO sensor integrated in AQMesh platform - Pearson correlation coefficient within 25 platforms, ATM Zeleno Brdo 19.5-26.6.2015.

PL No	695150	696150	702150	705150	714150	716150	722150	729150	730150	754150	763150	792150	809150	810150	812150	821150	827150	829150	839150	858150	859150	870150	872150	873150	875150
695150	1,00																								
696150	-0,05	1,00																							
702150	0,94	-0,10	1,00																						
705150	0,86	-0,16	0,90	1,00																					
714150	0,91	0,04	0,91	0,83	1,00																				
716150	0,92	-0,16	0,91	0,96	0,88	1,00																			
722150	0,45	0,73	0,44	0,25	0,53	0,28	1,00																		
729150	0,14	0,92	0,11	0,05	0,26	0,04	0,76	1,00																	
730150	0,51	0,69	0,50	0,31	0,59	0,34	0,98	0,75	1,00																
754150	0,94	0,01	0,97	0,85	0,94	0,87	0,55	0,24	0,60	1,00															
763150	0,44	0,76	0,41	0,24	0,50	0,26	0,98	0,80	0,97	0,53	1,00														
792150	0,05	-0,13	0,05	0,17	0,05	0,09	-0,17	-0,12	-0,15	0,05	-0,17	1,00													
809150	0,57	-0,39	0,64	0,66	0,49	0,64	-0,02	-0,31	0,00	0,56	-0,09	0,10	1,00												
810150	0,04	-0,11	0,04	0,13	0,06	0,06	-0,15	-0,10	-0,14	0,05	-0,15	0,74	0,07	1,00											
812150	0,09	-0,16	0,09	0,26	0,09	0,16	-0,19	-0,15	-0,17	0,07	-0,19	0,76	0,15	0,72	1,00										
821150	0,51	-0,41	0,59	0,61	0,42	0,60	-0,08	-0,35	-0,06	0,51	-0,15	0,12	0,99	0,08	0,17	1,00									
827150	0,06	-0,13	0,06	0,19	0,07	0,09	-0,18	-0,13	-0,16	0,05	-0,17	0,87	0,11	0,76	0,83	0,13	1,00								
829150	-0,29	0,91	-0,34	-0,38	-0,24	-0,38	0,57	0,72	0,52	-0,25	0,60	-0,13	-0,42	-0,11	-0,16	-0,44	-0,13	1,00							
839150	0,24	-0,42	0,34	0,42	0,14	0,35	-0,29	-0,38	-0,27	0,25	-0,34	0,20	0,81	0,14	0,27	0,86	0,21	-0,41	1,00						
858150	0,02	-0,27	0,02	-0,11	-0,03	-0,04	-0,21	-0,27	-0,19	0,03	-0,17	-0,12	-0,06			-0,05		-0,29	-0,06	1,00					
859150	0,03	-0,07	0,02	0,08	0,07	0,03	-0,11	-0,06	-0,10	0,03	-0,10	0,52	0,03	0,69	0,46	0,03	0,55	-0,07	0,07		1,00				
870150	0,54	-0,41	0,62	0,64	0,46	0,62	-0,05	-0,33	-0,03	0,54	-0,12	0,11	0,99	0,08	0,16	0,99	0,12	-0,43	0,82	-0,06	0,03	1,00			
872150	0,51	-0,41	0,59	0,61	0,43	0,59	-0,07	-0,34	-0,05	0,51	-0,14	0,10	0,99	0,07	0,15	1,00	0,10	-0,43	0,85	-0,06	0,03	1,00	1,00		
873150	0,52	-0,26	0,62	0,49	0,43	0,50	0,14	-0,20	0,15	0,56	0,08	-0,04	0,89	-0,05	-0,05	0,88	-0,05	-0,29	0,68	-0,05	-0,07	0,89	0,89	1,00	
875150	0,04	-0,09	0,02	0,11	0,07	0,05	-0,14	-0,08	-0,12	0,04	-0,13	0,63	0,04	0,85	0,64	0,05	0,67	-0,09	0,09		0,58	0,05	0,03	-0,08	1,00
<0,3																									
0.3<0.6																									
0.6<0.9																									
>0.9																									

ANNEX

D8.4 Sensor Platforms Enhancement



Table H2. Pearson correlation coefficients of each platform relative to all the others for AQMesh podes and EB700, per pollutant. O₃ sensor integrated in AQMesh platform - Pearson correlation coefficient within 25 platforms, ATM Zeleno Brdo 19.5-26.6.2015

PL No	695150	696150	702150	705150	714150	716150	722150	729150	730150	754150	763150	792150	809150	810150	812150	821150	827150	829150	839150	858150	859150	870150	872150	872150	873150	875150		
695150	1,00																											
696150	0,58	1,00																										
702150	0,08	0,00	1,00																									
705150	0,20	-0,02	0,29	1,00																								
714150	0,40	0,57	0,28	0,34	1,00																							
716150	0,62	0,78	0,15	0,19	0,89	1,00																						
722150	-0,37	0,02	0,29	0,23	0,58	0,33	1,00																					
729150	0,92	0,62	0,05	0,11	0,33	0,56	-0,47	1,00																				
730150	0,49	0,57	0,21	0,36	0,94	0,88	0,54	0,37	1,00																			
754150	-0,04	0,03	0,52	0,09	0,26	0,19	0,40	-0,11	0,20	1,00																		
763150																												
792150	0,31	0,65	0,20	0,22	0,94	0,91	0,62	0,24	0,89	0,27		1,00																
809150	0,57	0,40	0,13	0,33	0,63	0,59	0,18	0,41	0,76	0,06		0,53	1,00															
810150	0,79	0,75	0,13	0,26	0,73	0,84	0,09	0,71	0,81	0,09		0,69	0,80	1,00														
812150	0,65	0,31	0,03	0,26	0,41	0,42	-0,11	0,52	0,57	-0,08		0,25	0,91	0,72	1,00													
821150	0,30	0,62	0,31	0,16	0,90	0,87	0,58	0,31	0,80	0,29		0,91	0,37	0,61	0,14	1,00												
827150	0,10	0,59	0,21	0,18	0,88	0,81	0,73	0,06	0,81	0,28		0,95	0,36	0,52	0,07	0,92	1,00											
829150	0,07	0,53	0,20	0,20	0,89	0,79	0,80	0,01	0,84	0,30		0,94	0,43	0,53	0,14	0,88	0,97	1,00										
839150	0,78	0,60	0,01	0,23	0,60	0,69	-0,04	0,67	0,75	-0,04		0,51	0,89	0,88	0,90	0,39	0,33	0,36	1,00									
858150	0,05	-0,02	-0,14	-0,05	-0,15	-0,17	-0,32	0,07	-0,12	-0,15		-0,26	0,19	-0,01	0,33	-0,29	-0,29	-0,28	0,12	1,00								
859150	0,62	0,52	0,26	0,31	0,83	0,84	0,29	0,49	0,84	0,18		0,76	0,77	0,80	0,63	0,72	0,62	0,65	0,74	-0,02	1,00							
870150	0,84	0,66	0,07	0,07	0,45	0,65	-0,37	0,89	0,45	-0,12		0,37	0,53	0,74	0,60	0,43	0,21	0,15	0,73	0,20	0,65	1,00						
872150	0,83	0,62	0,03	0,24	0,64	0,74	-0,06	0,72	0,77	-0,03		0,55	0,85	0,89	0,86	0,43	0,36	0,37	0,98	0,13	0,77	0,77	1,00					
873150	0,57	0,56	0,31	0,31	0,89	0,87	0,31	0,53	0,84	0,15		0,82	0,62	0,75	0,47	0,84	0,72	0,71	0,64	-0,09	0,91	0,68	0,69	1,00				
875150	0,64	0,51	0,15	0,37	0,79	0,76	0,25	0,52	0,90	0,10		0,69	0,93	0,86	0,84	0,56	0,53	0,58	0,90	0,10	0,85	0,61	0,91	0,78	1,00			
<0,3																												
0.3<0.6																												
0.6<0.9																												
>0.9																												



Table H2. Pearson correlation coefficients of each platform relative to all the others for AQMesh nodes and EB700, per pollutant. CO sensor integrated in AQMesh platform - Pearson correlation coefficient within 25 platforms, ATM Zeleno Brdo 19.5-26.6.2015

PL No	695150	696150	702150	705150	714150	716150	722150	729150	730150	754150	763150	792150	809150	810150	812150	821150	827150	829150	839150	858150	859150	870150	872150	873150	875150	
695150	1,00																									
696150	0,93	1,00																								
702150	0,91	0,99	1,00																							
705150	0,93	0,99	0,98	1,00																						
714150	0,92	0,99	0,99	0,99	1,00																					
716150	0,94	0,98	0,98	0,98	0,98	1,00																				
722150	0,93	0,99	0,98	0,99	0,98	0,98	1,00																			
729150	0,92	0,98	0,98	0,99	0,98	0,97	0,98	1,00																		
730150	0,96	0,95	0,94	0,96	0,95	0,96	0,96	0,96	1,00																	
754150	0,93	0,98	0,96	0,98	0,97	0,97	1,00	0,98	0,96	1,00																
763150	0,93	0,98	0,97	0,99	0,98	0,98	0,98	0,97	0,95	0,98	1,00															
792150	0,89	0,94	0,92	0,95	0,94	0,95	0,94	0,92	0,90	0,95	0,98	1,00														
809150	0,92	0,98	0,98	0,98	0,98	0,97	0,98	0,97	0,95	0,98	0,98	0,95	1,00													
810150	0,93	0,97	0,96	0,98	0,96	0,97	0,98	0,98	0,96	0,99	0,98	0,95	0,96	1,00												
812150	0,93	0,97	0,96	0,98	0,96	0,99	0,97	0,96	0,96	0,97	0,98	0,96	0,96	0,98	1,00											
821150	0,88	0,92	0,91	0,94	0,93	0,95	0,93	0,91	0,90	0,93	0,96	0,98	0,93	0,93	0,97	1,00										
827150	0,88	0,93	0,92	0,94	0,93	0,95	0,94	0,91	0,91	0,94	0,97	0,98	0,95	0,94	0,97	0,99	1,00									
829150	0,94	0,96	0,94	0,96	0,95	0,96	0,96	0,94	0,95	0,95	0,99	0,99	0,96	0,96	0,97	0,98	0,98	1,00								
839150	0,80	0,85	0,87	0,87	0,89	0,88	0,85	0,83	0,82	0,84	0,89	0,91	0,87	0,83	0,89	0,92	0,91	0,89	1,00							
858150	0,31	0,24	0,24	0,25	0,23	0,27	0,27	0,26	0,27	0,28	0,28	0,28	0,25	0,30	0,30	0,29	0,28	0,27	0,15	1,00						
859150	0,93	0,93	0,92	0,95	0,94	0,95	0,94	0,92	0,91	0,94	0,97	0,97	0,94	0,94	0,96	0,97	0,96	0,97	0,90	0,29	1,00					
870150	0,90	0,95	0,94	0,96	0,96	0,96	0,95	0,94	0,92	0,95	0,99	0,99	0,95	0,95	0,97	0,98	0,98	0,99	0,91	0,29	0,97	1,00				
872150	0,92	0,98	0,96	0,99	0,98	0,98	0,98	0,97	0,94	0,97	0,99	0,98	0,98	0,97	0,98	0,97	0,97	0,99	0,89	0,27	0,97	0,99	1,00			
873150	0,97	0,96	0,95	0,96	0,95	0,97	0,96	0,96	0,99	0,95	0,95	0,90	0,96	0,95	0,95	0,91	0,91	0,96	0,84	0,27	0,92	0,92	0,94	1,00		
875150	0,66	0,57	0,53	0,61	0,58	0,60	0,58	0,56	0,61	0,58	0,63	0,65	0,57	0,61	0,60	0,64	0,64	0,66	0,54	0,42	0,63	0,65	0,63	0,61	1,00	
<0,3																										
0.3<0.6																										
0.6<0.9																										
>0.9																										

ANNEX

D8.4 Sensor Platforms Enhancement



**Table H2. Pearson correlation coefficients of each platform relative to all the others for AQMesh nodes and EB700, per pollutant.
Total count sensor integrated in AQMesh platform - Pearson correlation coefficient within 25 platforms, ATM Zeleno Brdo 19.5-26.6.2015**

PL No	695150	696150	702150	705150	714150	716150	722150	729150	730150	754150	763150	792150	809150	810150	812150	821150	827150	829150	839150	858150	859150	870150	872150	873150	875150	
695150	1,00																									
696150	0,90	1,00																								
702150	0,89	0,97	1,00																							
705150	0,91	0,94	0,96	1,00																						
714150	0,88	0,94	0,98	0,97	1,00																					
716150	0,90	0,96	0,98	0,96	0,98	1,00																				
722150	0,87	0,94	0,99	0,94	0,98	0,95	1,00																			
729150	0,95	0,98	0,98	0,98	0,97	0,98		1,00																		
730150	0,76	0,82	0,84	0,81	0,83	0,83	0,98	0,78	1,00																	
754150	0,89	0,97	0,98	0,96	0,98	0,98	0,95	0,98	0,83	1,00																
763150	0,92	0,96	0,98	0,98	0,99	0,99		0,97	0,79	0,99	1,00															
792150	0,92	0,98	1,00	0,98	0,98	0,99		0,98	0,80	0,99	0,98	1,00														
809150	0,95	0,93	0,91	0,91	0,87	0,92	0,87	0,97	0,77	0,92	0,92	0,95	1,00													
810150	0,91	0,98	0,99	0,96	0,96	0,97	0,98	0,98	0,83	0,98	0,98	0,99	0,94	1,00												
812150	0,94	0,98	0,97	0,95	0,93	0,96	0,94	0,99	0,82	0,96	0,96	0,98	0,97	0,98	1,00											
821150	0,90	0,95	0,97	0,95	0,96	0,97	0,96	0,99	0,81	0,97	0,97	0,98	0,91	0,96	0,96	1,00										
827150	0,94	0,95	0,96	0,97	0,96	0,96	0,96	0,98	0,81	0,95	0,98	0,97	0,94	0,96	0,96	0,95	1,00									
829150	0,89	0,90	0,89	0,89	0,87	0,90	0,84	0,99	0,83	0,90	0,97	0,98	0,94	0,92	0,93	0,88	0,91	1,00								
839150	0,76	0,79	0,82	0,82	0,83	0,82	0,98	0,78	0,71	0,82	0,79	0,78	0,76	0,82	0,80	0,81	0,82	0,81	1,00							
858150	0,14	-0,11	-0,01	-0,01	-0,07	0,18	0,00		-0,03	0,07			0,29	0,03	0,08	-0,01	0,01	0,24	-0,04	1,00						
859150	0,97	0,95	0,93	0,93	0,91	0,94	0,92	0,97	0,80	0,94	0,94	0,96	0,98	0,96	0,98	0,93	0,96	0,93	0,79	0,12	1,00					
870150	0,83	0,94	0,98	0,95	0,98	0,97	0,96	0,96	0,83	0,97	0,99	0,98	0,85	0,96	0,92	0,94	0,93	0,85	0,81	-0,07	0,89	1,00				
872150	0,88	0,94	0,98	0,96	0,99	0,98	0,96	0,97	0,90	0,97	0,99	0,99	0,88	0,97	0,93	0,96	0,96	0,87	0,83	-0,10	0,91	0,98	1,00			
873150	0,77	0,79	0,82	0,81	0,82	0,82	0,96	0,78	0,79	0,82	0,80	0,79	0,77	0,81	0,81	0,81	0,81	0,89	0,71	0,02	0,80	0,81	0,86	1,00		
875150	0,91	0,96	0,98	0,96	0,97	0,99	0,95	0,98	0,85	0,98	0,98	0,99	0,94	0,98	0,97	0,97	0,97	0,91	0,82	0,09	0,96	0,96	0,98	0,84	1,00	
0,3																										
0.3<0.6																										
0.6<0.9																										
>0.9																										



**Table H2. Pearson correlation coefficients of each platform relative to all the others for AQMesh nodes and EB700, per pollutant.
Temperature sensor integrated in AQMesh platform - Pearson correlation coefficient within 25 platforms, ATM Zeleno Brdo 19.5-26.6.2015**

PL No	695150	696150	702150	705150	714150	716150	722150	729150	730150	754150	763150	792150	809150	810150	812150	821150	827150	829150	839150	858150	859150	870150	872150	873150	875150		
695150	1,00																										
696150	0,98	1,00																									
702150	0,99	1,00	1,00																								
705150	0,98	1,00	1,00	1,00																							
714150	0,98	1,00	1,00	1,00	1,00																						
716150	0,99	1,00	1,00	1,00	1,00	1,00																					
722150	0,99	1,00	1,00	1,00	1,00	1,00	1,00																				
729150	0,98	1,00	1,00	1,00	1,00	1,00	1,00	1,00																			
730150	0,98	0,99	0,99	1,00	1,00	1,00	1,00	1,00	1,00																		
754150	0,99	1,00	1,00	1,00	1,00	0,99	1,00	1,00	0,99	1,00																	
763150	0,98	1,00	1,00	1,00	1,00	1,00	1,00	1,00	1,00	1,00	1,00																
792150	0,99	1,00	1,00	1,00	1,00	1,00	1,00	1,00	1,00	1,00	1,00	1,00															
809150	0,98	1,00	1,00	1,00	1,00	1,00	1,00	1,00	1,00	1,00	1,00	1,00	1,00														
810150	0,99	1,00	1,00	1,00	1,00	1,00	1,00	1,00	1,00	1,00	1,00	1,00	1,00	1,00													
812150	0,99	1,00	1,00	1,00	1,00	1,00	1,00	1,00	1,00	1,00	1,00	1,00	1,00	1,00	1,00												
821150	0,99	0,99	0,99	1,00	1,00	1,00	0,99	1,00	1,00	0,99	1,00	0,99	0,99	0,99	1,00	1,00											
827150	0,98	1,00	1,00	1,00	1,00	1,00	1,00	1,00	1,00	1,00	1,00	1,00	1,00	1,00	1,00	1,00	1,00										
829150	0,98	1,00	1,00	1,00	1,00	1,00	1,00	1,00	1,00	1,00	1,00	1,00	1,00	1,00	1,00	0,99	1,00	1,00									
839150	0,98	1,00	1,00	1,00	1,00	1,00	1,00	1,00	1,00	1,00	1,00	1,00	1,00	1,00	1,00	1,00	1,00	1,00	1,00								
858150	0,58	0,51	0,52	0,50	0,52	0,52	0,53	0,52	0,52	0,53	0,52	0,52	0,51	0,53	0,52	0,52	0,52	0,52	0,50	1,00							
859150	1,00	0,99	0,99	0,99	0,99	0,99	0,99	0,99	0,99	0,99	0,99	0,99	0,99	0,99	0,99	0,99	0,99	0,99	0,99	0,57	1,00						
870150	0,98	1,00	1,00	1,00	1,00	1,00	0,99	1,00	1,00	1,00	1,00	1,00	1,00	0,99	1,00	1,00	1,00	1,00	1,00	0,52	0,99	1,00					
872150	0,98	1,00	1,00	1,00	1,00	1,00	1,00	1,00	1,00	1,00	1,00	1,00	1,00	1,00	1,00	1,00	1,00	1,00	1,00	0,51	0,99	1,00	1,00				
873150	0,98	0,99	0,99	1,00	1,00	1,00	0,99	1,00	1,00	0,99	1,00	0,99	0,99	0,99	1,00	1,00	1,00	0,99	1,00	0,52	0,99	1,00	1,00	1,00			
875150	0,98	1,00	1,00	1,00	1,00	1,00	1,00	1,00	1,00	0,99	1,00	1,00	1,00	1,00	1,00	1,00	1,00	0,99	1,00	0,52	0,99	1,00	1,00	1,00	1,00		
<0,3																											
0.3<0.6																											
0.6<0.9																											
>0.9																											

ANNEX

D8.4 Sensor Platforms Enhancement



Table H2. Pearson correlation coefficients of each platform relative to all the others for AQMesh nodes and EB700, per pollutant. RH sensor integrated in AQMesh platform - Pearson correlation coefficient within 25 platforms, ATM Zeleno Brdo 19.5-26.6.2015

	695150	696150	702150	705150	714150	716150	722150	729150	730150	754150	763150	792150	809150	810150	812150	821150	827150	829150	839150	858150	859150	870150	872150	873150	875150	
695150	1,00																									
696150	0,99	1,00																								
702150	0,99	1,00	1,00																							
705150	0,99	1,00	1,00	1,00																						
714150	0,99	1,00	1,00	1,00	1,00																					
716150	0,99	1,00	1,00	1,00	1,00	1,00																				
722150	0,99	1,00	1,00	1,00	1,00	1,00	1,00																			
729150	0,99	1,00	1,00	1,00	1,00	1,00	1,00	1,00																		
730150	0,99	1,00	1,00	1,00	1,00	1,00	1,00	1,00	1,00																	
754150	0,99	1,00	1,00	0,99	1,00	1,00	1,00	0,99	0,99	1,00																
763150	0,99	1,00	1,00	1,00	1,00	1,00	1,00	1,00	1,00	1,00	1,00															
792150	0,99	1,00	1,00	1,00	1,00	1,00	1,00	1,00	1,00	1,00	1,00	1,00														
809150	0,99	1,00	1,00	1,00	1,00	1,00	1,00	1,00	1,00	1,00	1,00	1,00	1,00													
810150	0,99	1,00	1,00	1,00	1,00	1,00	1,00	1,00	1,00	1,00	1,00	1,00	1,00	1,00												
812150	0,99	1,00	1,00	1,00	1,00	1,00	1,00	1,00	1,00	1,00	1,00	1,00	1,00	1,00	1,00											
821150	0,99	1,00	1,00	1,00	1,00	1,00	1,00	1,00	1,00	1,00	1,00	1,00	1,00	1,00	1,00	1,00										
827150	0,98	0,99	0,99	0,99	0,99	0,99	0,99	0,99	1,00	0,99	0,99	0,99	0,99	0,99	0,99	0,99	1,00									
829150	0,99	1,00	1,00	1,00	1,00	1,00	1,00	1,00	1,00	1,00	1,00	1,00	1,00	1,00	1,00	1,00	0,99	1,00								
839150	0,99	1,00	1,00	1,00	1,00	1,00	1,00	1,00	1,00	1,00	1,00	1,00	1,00	1,00	1,00	1,00	0,99	1,00	1,00							
858150	0,35	0,30	0,31	0,29	0,30	0,30	0,32	0,30	0,32	0,31	0,31	0,31	0,30	0,31	0,31	0,30	0,34	0,30	0,29	1,00						
859150	0,99	0,99	0,99	0,99	0,99	0,99	0,99	0,99	0,99	0,99	0,99	0,99	0,99	0,99	0,99	0,99	0,98	0,99	0,99	0,33	1,00					
870150	0,99	1,00	1,00	1,00	1,00	1,00	1,00	1,00	1,00	1,00	1,00	1,00	1,00	1,00	1,00	1,00	0,99	1,00	1,00	0,31	0,99	1,00				
872150	0,99	1,00	1,00	1,00	1,00	1,00	1,00	1,00	1,00	1,00	1,00	1,00	1,00	1,00	1,00	1,00	0,99	1,00	1,00	0,30	0,99	1,00	1,00			
873150	0,98	0,99	0,99	0,99	1,00	1,00	0,99	0,99	0,99	0,99	1,00	0,99	0,99	0,99	0,99	1,00	0,99	0,99	0,99	0,33	0,99	1,00	0,99	1,00		
875150	0,99	1,00	1,00	1,00	1,00	1,00	1,00	1,00	1,00	1,00	1,00	1,00	1,00	1,00	1,00	1,00	0,99	1,00	1,00	0,30	0,99	1,00	1,00	1,00	1,00	1,00
<0,3																										
0.3<0.6																										
0.6<0.9																										
>0.9																										



Table H2. Pearson correlation coefficients of each platform relative to all the others for AQMesh nodes and EB700, per pollutant. Atmospheric pressure sensor integrated in AQMesh platform - Pearson correlation coefficient within 25 platforms, ATM Zeleno Brdo 19.5-26.6.2015

PL No	695150	696150	702150	705150	714150	716150	722150	729150	730150	754150	763150	792150	809150	810150	812150	821150	827150	829150	839150	858150	859150	870150	872150	873150	875150	
695150	1,00																									
696150	0,99	1,00																								
702150	0,97	0,98	1,00																							
705150	0,99	0,99	0,98	1,00																						
714150	0,99	0,99	0,96	0,99	1,00																					
716150	0,99	0,99	0,96	0,99	0,99	1,00																				
722150	0,99	0,99	0,98	0,99	0,99	0,99	1,00																			
729150	0,99	0,99	0,97	0,99	0,99	0,99	0,99	1,00																		
730150	0,98	0,99	0,99	0,99	0,98	0,98	0,99	0,98	1,00																	
754150	0,98	0,99	0,99	0,99	0,98	0,97	0,99	0,98	0,99	1,00																
763150	0,99	0,99	0,98	0,99	0,99	0,99	0,99	0,99	0,99	0,99	1,00															
792150	0,98	0,99	0,99	0,99	0,98	0,98	0,99	0,98	0,99	0,99	0,99	1,00														
809150	0,99	0,99	0,97	0,99	0,99	0,99	0,99	0,99	0,98	0,98	0,99	0,98	1,00													
810150	0,99	0,99	0,98	0,99	0,99	0,99	0,99	0,99	0,99	0,98	0,99	0,99	0,99	1,00												
812150	0,99	0,99	0,99	0,99	0,99	0,99	0,99	0,99	0,99	0,99	0,99	0,99	0,99	0,99	1,00											
821150	0,99	0,99	0,96	0,99	0,99	0,99	0,99	0,99	0,98	0,98	0,98	0,98	0,99	0,99	0,99	1,00										
827150	0,99	0,99	0,98	0,99	0,99	0,99	0,99	0,99	0,99	0,99	0,99	0,99	0,99	0,99	1,00	0,99	1,00									
829150	0,99	0,99	0,99	0,99	0,99	0,98	0,99	0,98	0,99	0,99	0,99	0,99	0,99	0,99	0,99	0,98	0,99	1,00								
839150	0,99	0,99	0,97	0,99	0,99	0,99	0,99	0,99	0,98	0,98	0,99	0,99	0,99	0,99	0,99	0,99	0,99	0,98	1,00							
858150	0,74	0,74	0,67	0,74	0,75	0,74	0,74	0,74	0,71	0,68	0,74	0,71	0,76	0,76	0,73	0,74	0,76	0,73	0,74	1,00						
859150	0,99	0,99	0,98	0,99	0,99	0,99	0,99	0,99	0,99	0,99	0,99	0,99	0,99	0,99	0,99	0,99	0,99	0,99	0,99	0,74	1,00					
870150	0,99	0,99	0,99	0,99	0,98	0,98	0,99	0,99	0,99	0,99	0,99	0,99	0,99	0,99	0,99	0,98	0,99	0,99	0,99	0,72	0,99	1,00				
872150	0,99	0,99	0,99	0,99	0,99	0,99	0,99	0,99	0,99	0,99	0,99	0,99	0,99	0,99	0,99	0,98	0,99	0,99	0,99	0,73	0,99	0,99	1,00			
873150	0,99	0,99	0,98	0,99	0,99	0,99	0,99	0,99	0,99	0,99	0,99	0,99	0,99	0,99	0,99	0,99	0,99	0,99	0,99	0,76	0,99	0,99	0,99	1,00		
875150	0,93	0,95	0,98	0,94	0,92	0,92	0,95	0,94	0,97	0,97	0,95	0,97	0,93	0,94	0,96	0,93	0,95	0,96	0,93	0,60	0,95	0,96	0,96	0,95	1,00	
<0,3																										
0.3<0.6																										
0.6<0.9																										
>0.9																										

Table H2. Pearson correlation coefficients of each platform relative to all other platforms, for AQMesh nodes and EB700. NO₂ sensor integrated in EB700 platform - Pearson correlation coefficient within 10 EB platforms, ATM Zeleno Brdo 19.5-26.6.2015

PL No	2	3	4	5	6	7	8	9	10	13
2	1,00									
3	0,75	1,00								
4	0,16	0,31	1,00							
5	0,78	0,93	0,42	1,00						
6	0,70	0,73	0,41	0,86	1,00					
7	0,82	0,86	0,43	0,82	0,65	1,00				
8	0,73	0,91	0,44	0,95	0,86	0,82	1,00			
9	0,85	0,95	0,39	0,94	0,84	0,83	0,96	1,00		
10	0,82	0,94	0,40	0,91	0,77	0,87	0,95	0,97	1,00	
13	0,85	0,91	0,38	0,88	0,69	0,91	0,89	0,92	0,95	1,00

Table H2. NO sensor integrated in EB700 platform - Pearson correlation coefficient within 10 EB platforms, ATM Zeleno Brdo 19.5-26.6.2015

PL No	2	3	4	5	6	7	8	9	10	13
2	1,00									
3	0,84	1,00								
4	0,16	0,22	1,00							
5	0,84	0,98	0,19	1,00						
6	0,85	0,96	0,25	0,97	1,00					
7	0,92	0,75	0,26	0,74	0,76	1,00				
8	0,84	0,94	0,26	0,95	0,98	0,77	1,00			
9	0,81	0,89	0,21	0,91	0,93	0,72	0,93	1,00		
10	0,80	0,79	0,36	0,78	0,87	0,82	0,88	0,79	1,00	
13	0,89	0,86	0,21	0,87	0,89	0,79	0,89	0,89	0,77	1,00

<0,3	
0.3<0.6	
0.6<0.9	
>0.9	

Table H2. CO sensor integrated in EB700 platform - Pearson correlation coefficient within 10 EB platforms, ATM Zeleno Brdo 19.5-26.6.2015

PL No	2	3	4	5	6	7	8	9	10	13
2	1,00									
3	0,92	1,00								
4	0,16	0,51	1,00							
5	0,94	0,95	0,49	1,00						
6	0,94	0,98	0,46	0,96	1,00					
7	0,95	0,90	0,53	0,90	0,91	1,00				
8	0,96	0,96	0,49	0,97	0,99	0,90	1,00			
9	0,95	0,96	0,50	0,95	0,98	0,89	0,99	1,00		
10	0,92	0,96	0,60	0,91	0,97	0,92	0,95	0,94	1,00	
13	0,93	0,95	0,55	0,95	0,97	0,96	0,96	0,95	0,96	1,00

Table H2. O₃ sensor integrated in EB700 platform - Pearson correlation coefficient within 10 EB platforms, ATM Zeleno Brdo 19.5-26.6.2015

PL No	2	3	4	5	6	7	8	9	10	13
2	1,00									
3	0,25	1,00								
4	-0,22	-0,15	1,00							
5	0,52	0,28	0,25	1,00						
6	0,63	0,51	0,15	0,89	1,00					
7	0,57	0,10	0,20	0,75	0,51	1,00				
8	0,46	0,69	0,16	0,81	0,94	0,49	1,00			
9	0,19	0,88	-0,26	-0,03	0,24	-0,18	0,46	1,00		
10	0,11	0,85	-0,16	0,17	0,41	-0,10	0,66	0,90	1,00	
13	0,63	0,02	0,12	0,60	0,40	0,80	0,37	-0,17	-0,11	1,00

<0,3	
0.3<0.6	
0.6<0.9	
>0.9	

Table H2. TEMPERATURE sensor integrated in EB700 platform - Pearson correlation coefficient within 10 EB platforms, ATM Zeleno Brdo 19.5-26.6.2015

PL No	2	3	4	5	6	7	8	9	10	13
2	1,00									
3	0,89	1,00								
4	0,26	0,40	1,00							
5	0,89	1,00	0,39	1,00						
6	0,90	0,99	0,35	0,99	1,00					
7	0,95	0,97	0,37	0,96	0,96	1,00				
8	0,90	0,99	0,41	0,99	1,00	0,96	1,00			
9	0,92	0,99	0,40	0,99	1,00	0,97	1,00	1,00		
10	0,91	0,98	0,41	0,98	0,99	0,98	0,99	0,99	1,00	
13	0,89	0,97	0,40	0,97	0,98	0,97	0,98	0,98	0,99	1,00

Table H2. RH sensor integrated in EB700 platform - Pearson correlation coefficient within 10 EB platforms, ATM Zeleno Brdo 19.5-26.6.2015

PL No	2	3	4	5	6	7	8	9	10	13
2	1,00									
3	0,92	1,00								
4	0,41	0,27	1,00							
5	0,92	1,00	0,28	1,00						
6	0,93	1,00	0,33	0,99	1,00					
7	0,97	0,97	0,29	0,97	0,97	1,00				
8	0,93	0,99	0,30	0,99	1,00	0,97	1,00			
9	0,94	0,99	0,29	0,99	1,00	0,98	1,00	1,00		
10	0,94	0,99	0,29	0,99	0,99	0,98	0,99	1,00	1,00	
13	0,93	0,98	0,29	0,98	0,99	0,98	0,99	0,99	0,99	1,00

<0,3	
0.3<0.6	
0.6<0.9	
>0.9	

Table H2. Pressure sensor integrated in EB700 platform - Pearson correlation coefficient within 10 EB platforms, ATM Zeleno Brdo 19.5-26.6.2015

	2	3	4	5	6	7	8	9	10	13
2	1,00									
3	1,00	1,00								
4	0,99	0,95	1,00							
5	1,00	1,00	0,95	1,00						
6	1,00	1,00	0,96	1,00	1,00					
7	1,00	1,00	0,95	1,00	1,00	1,00				
8	1,00	1,00	0,97	1,00	1,00	0,99	1,00			
9	1,00	1,00	0,96	1,00	1,00	1,00	1,00	1,00		
10	1,00	1,00	0,95	1,00	1,00	1,00	1,00	1,00	1,00	
13	1,00	1,00	0,96	1,00	1,00	1,00	1,00	1,00	1,00	1,00

<0,3	
0.3<0.6	
0.6<0.9	
>0.9	



ANNEX

D8.4 Sensor platforms enhancement

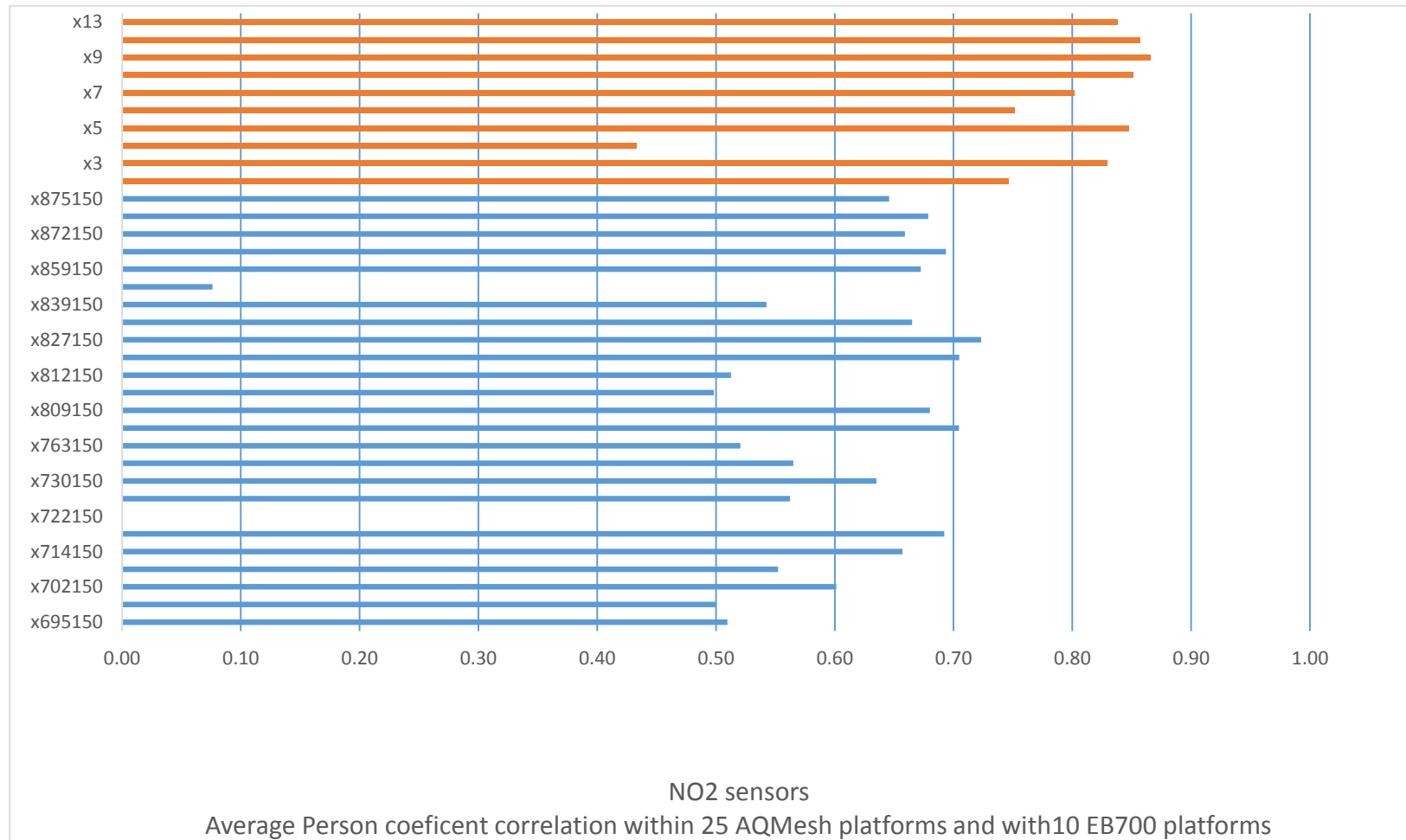

Figure H4. Average Pearson correlation coefficients of each platform relative to all the others for AQMesh nodes and EB700.

ANNEX

D8.4 Sensor Platforms Enhancement

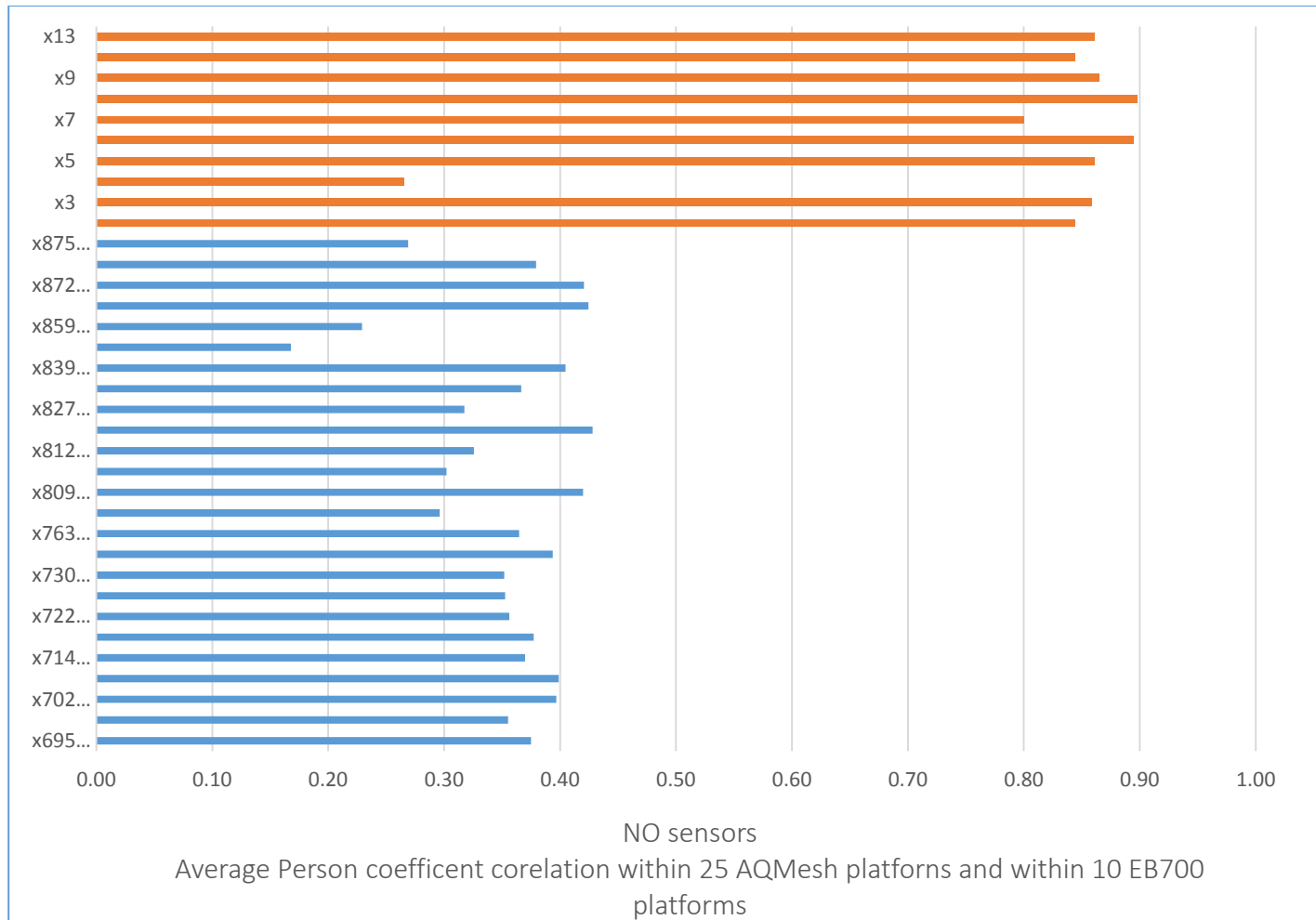

Figure H4. Average Pearson correlation coefficients of each platform relative to all the others for AQMesh nodes and EB700.

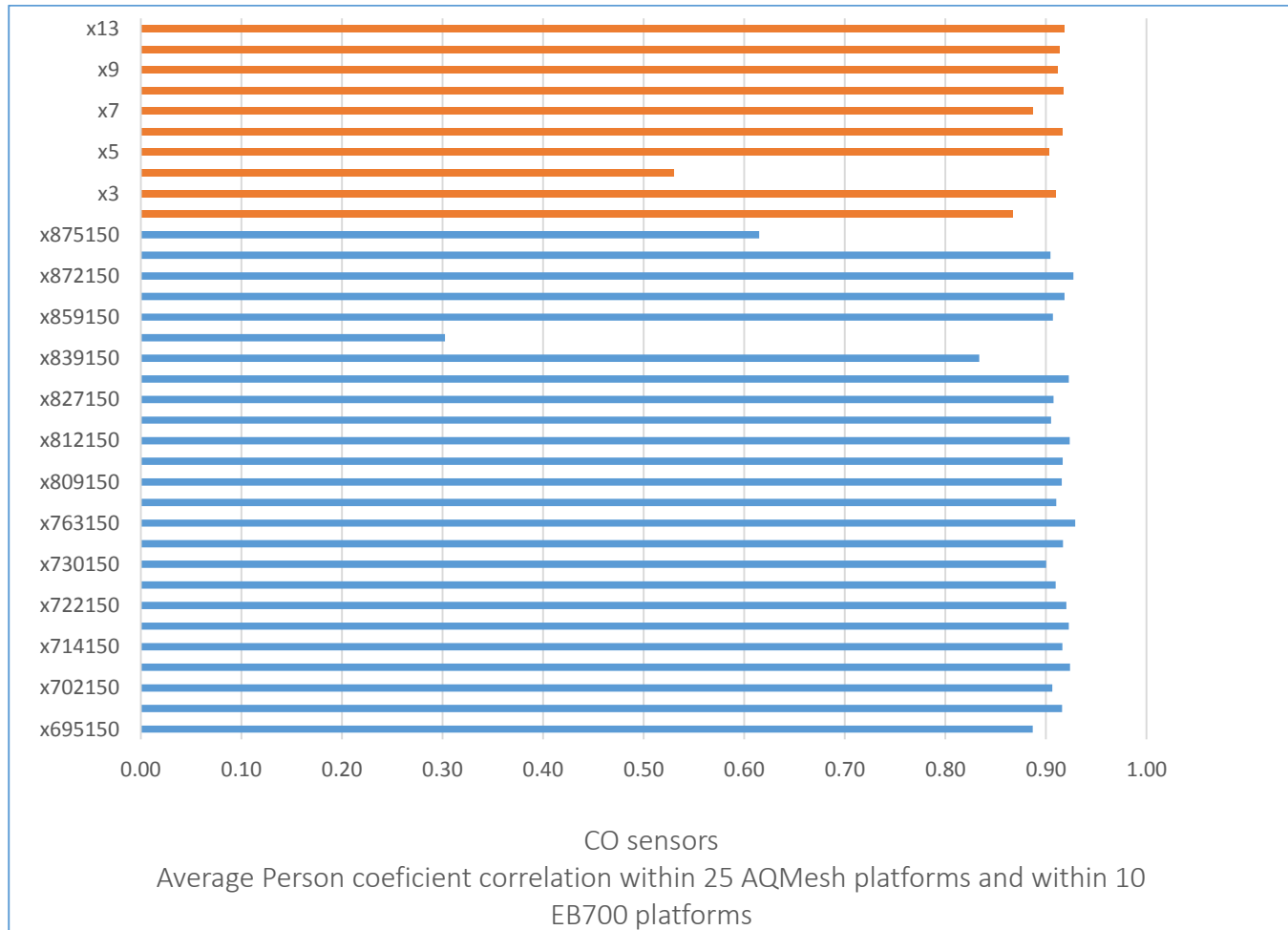

Figure H4. Average Pearson correlation coefficients of each platform relative to all the others for AQMesh podes and EB700.

ANNEX

D8.4 Sensor Platforms Enhancement

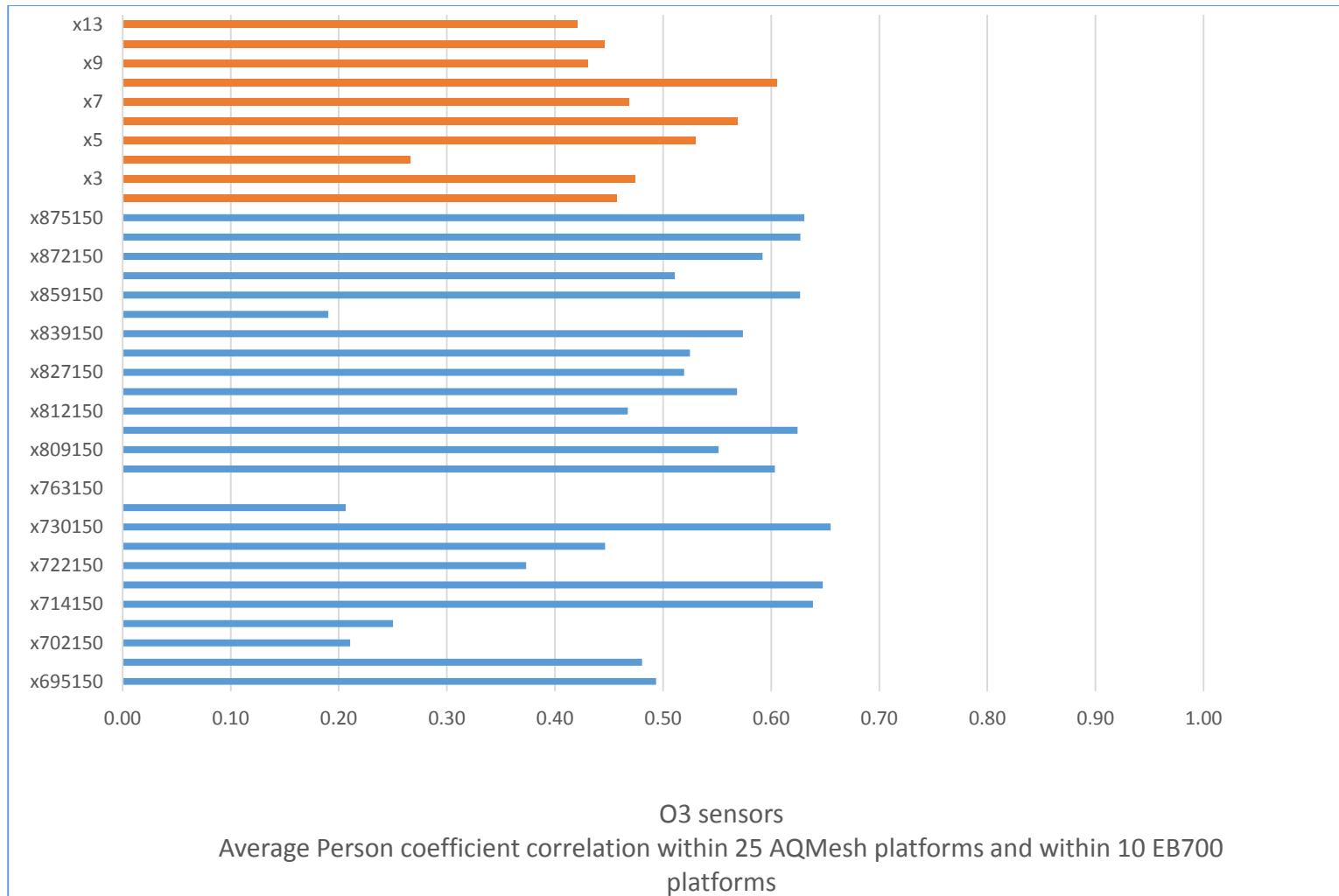

Figure H4. Average Pearson correlation coefficients of each platform relative to all the others for AQMesh nodes and EB700.

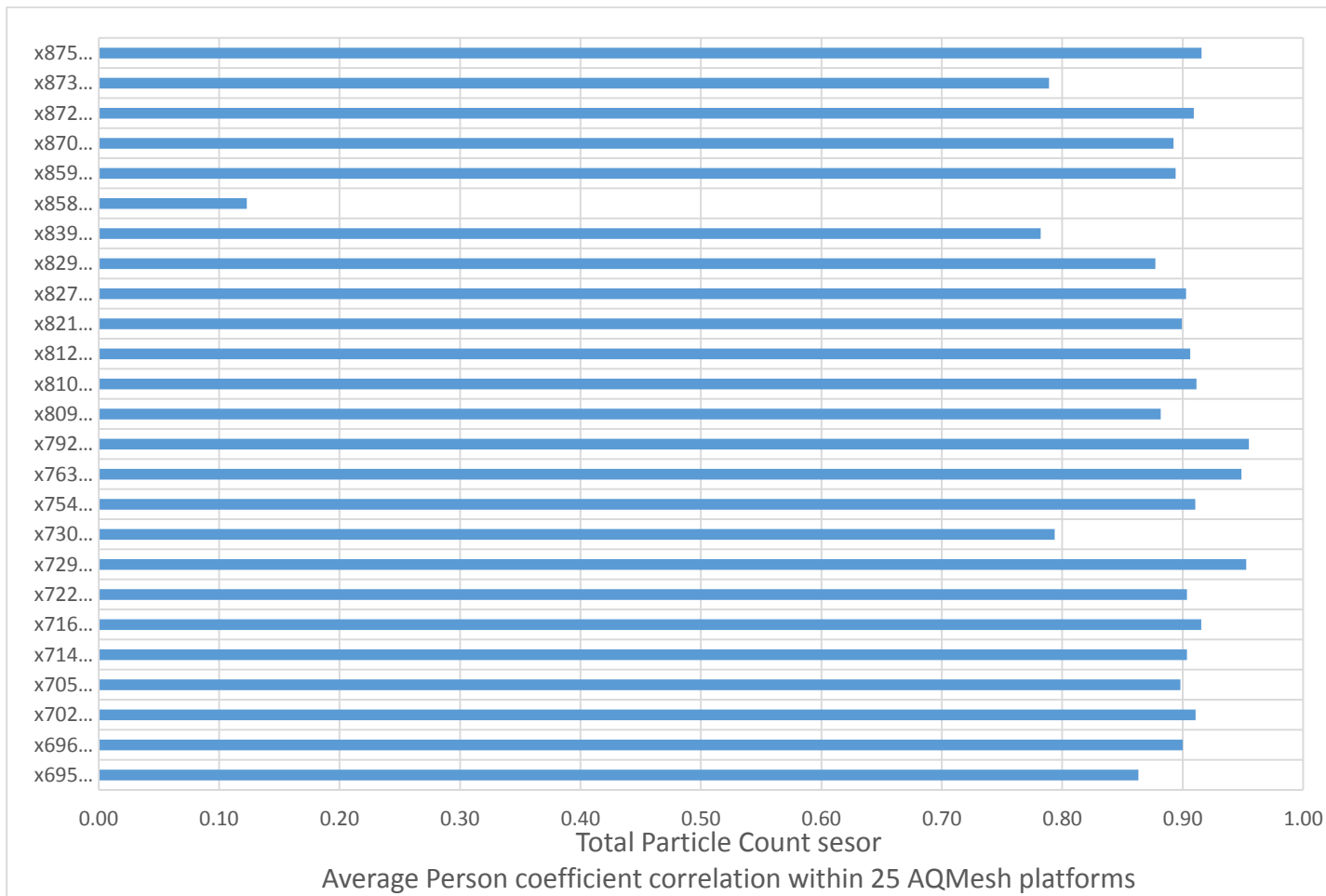

Figure H4. Average Pearson correlation coefficients of each platform relative to all the others for AQMesh podes and EB700.

ANNEX

D8.4 Sensor Platforms Enhancement

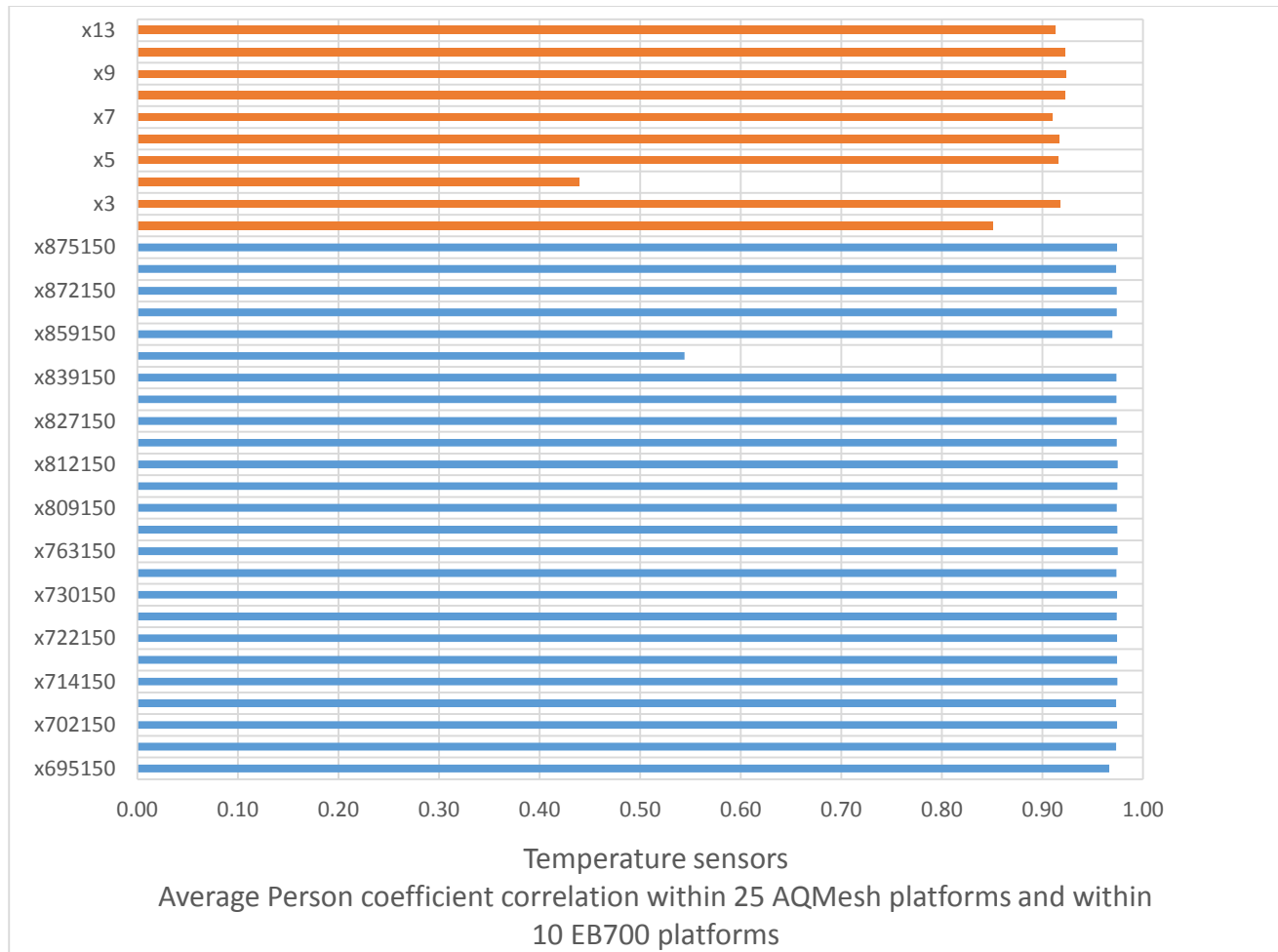

Figure H4. Average Pearson correlation coefficients of each platform relative to all the others for AQMesh podes and EB700.

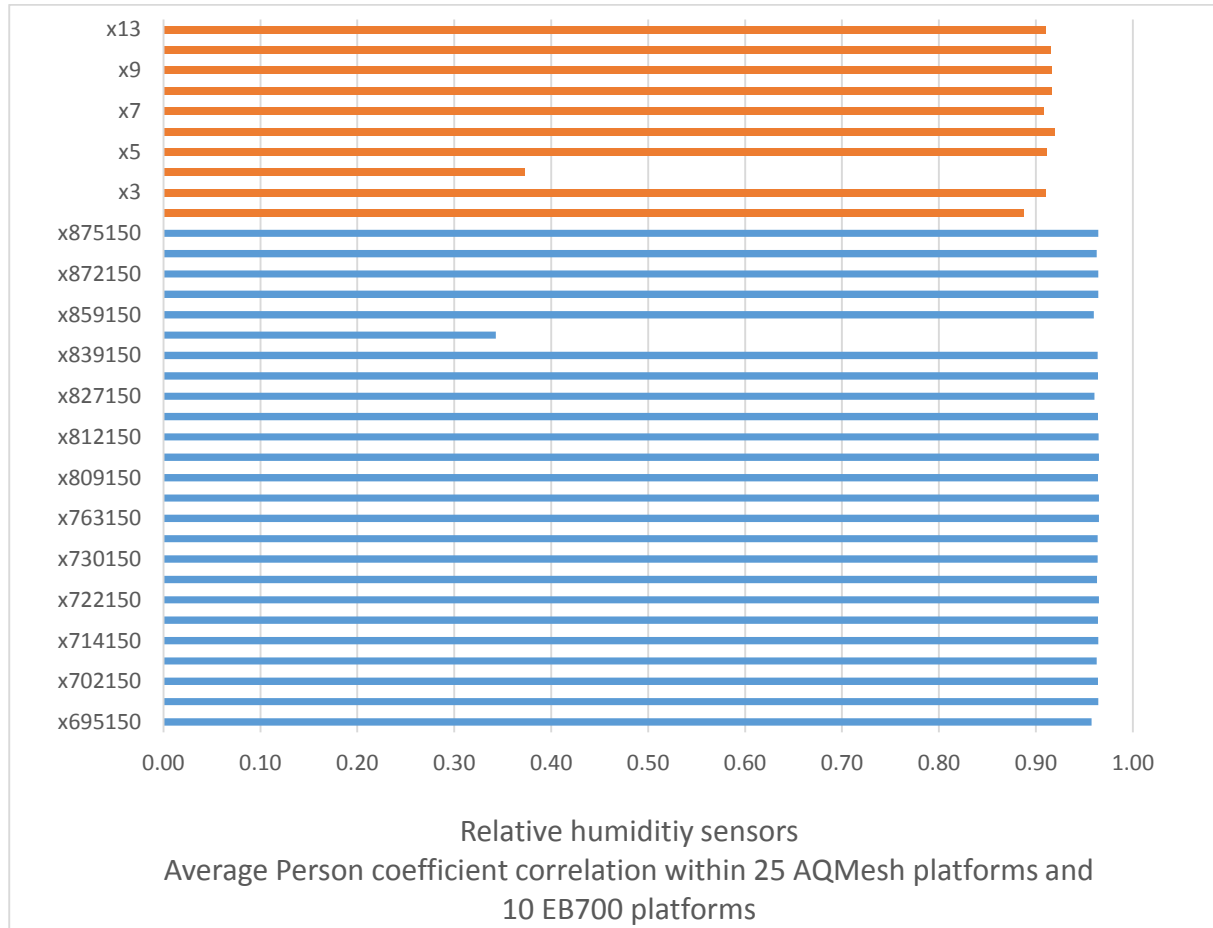

Figure H4. Average Pearson correlation coefficients of each platform relative to all the others for AQMesh podes and EB700.

ANNEX

D8.4 Sensor Platforms Enhancement

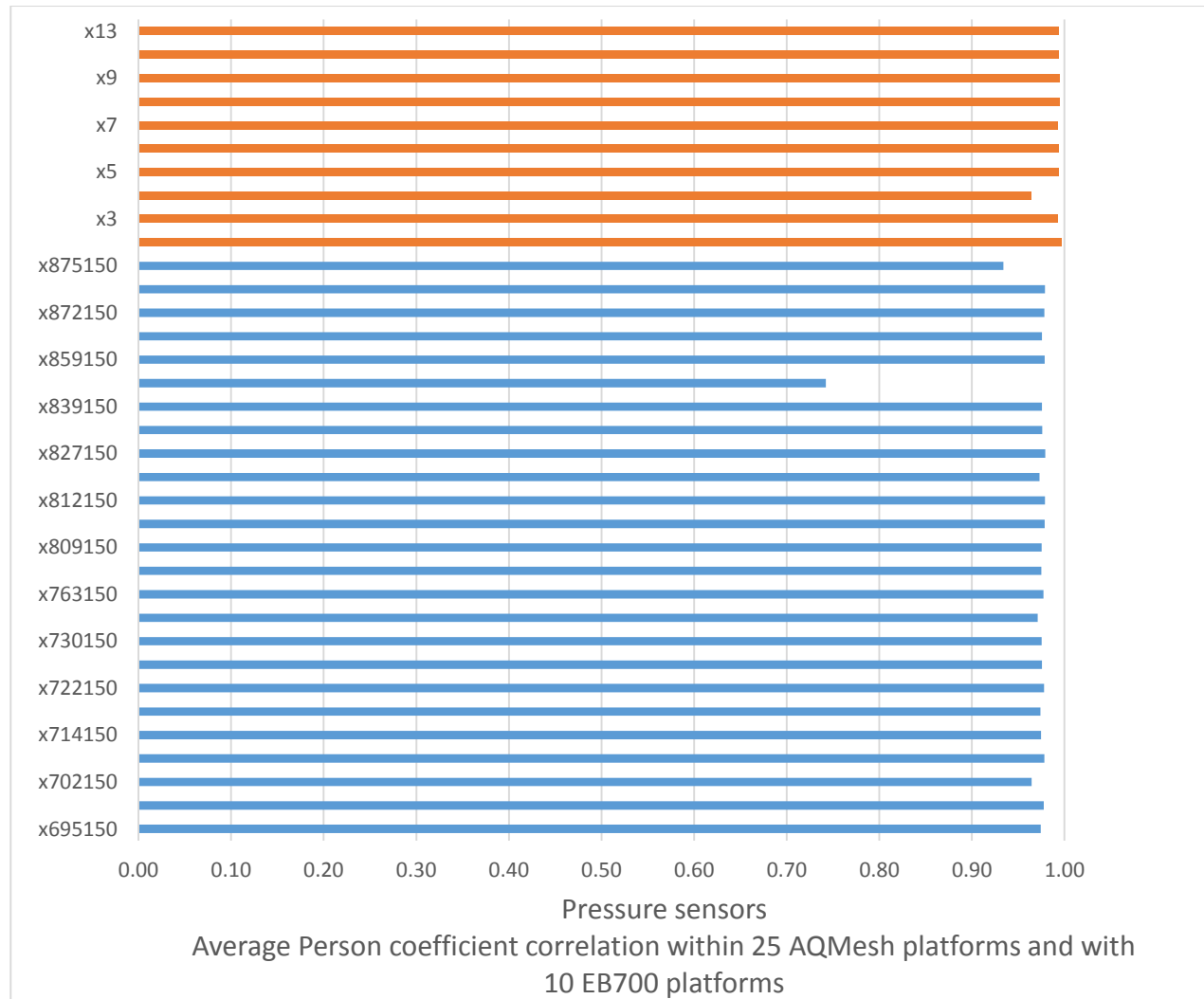

Figure H4. Average Pearson correlation coefficients of each platform relative to all the others for AQMesh nodes and EB700.